

ALLEN & HEATH



PA-CP Series

Powered Mixer

USER GUIDE

Publication AP4956

Limited One Year Warranty

This product is warranted to be free from defects in materials or workmanship for period of one year from the date of purchase by the original owner.

To ensure a high level of performance and reliability for which this equipment has been designed and manufactured, read this User Guide before operating.

In the event of a failure, notify and return the defective unit to ALLEN & HEATH Limited or its authorised agent as soon as possible for repair under warranty subject to the following conditions

Conditions Of Warranty

1. The equipment has been installed and operated in accordance with the instructions in this User Guide.
2. The equipment has not been subject to misuse either intended or accidental, neglect, or alteration other than as described in the User Guide or Service Manual, or approved by ALLEN & HEATH.
3. Any necessary adjustment, alteration or repair has been carried out by ALLEN & HEATH or its authorised agent.
4. This warranty does not cover fader wear and tear.
5. The defective unit is to be returned carriage prepaid to ALLEN & HEATH or its authorised agent with proof of purchase.
6. Units returned should be packed to avoid transit damage.

In certain territories the terms may vary. Check with your ALLEN & HEATH agent for any additional warranty which may apply.

 This product complies with the European Electromagnetic Compatibility directives 89/336/EEC & 92/31/EEC and the European Low Voltage Directives 73/23/EEC & 93/68/EEC.

This product has been tested to EN55103 Parts 1 & 2 1996 for use in Environments E1, E2, E3, and E4 to demonstrate compliance with the protection requirements in the European EMC directive 89/336/EEC. During some tests the specified performance figures of the product were affected. This is considered permissible and the product has been passed as acceptable for its intended use.

Allen & Heath has a strict policy of ensuring all products are tested to the latest safety and EMC standards. Customers requiring more information about EMC and safety issues can contact Allen & Heath.

NOTE: Any changes or modifications to the console not approved by Allen & Heath could void the compliance of the console and therefore the users authority to operate it.

PA-CP Series User Guide AP4956 Issue 4

Copyright © 2005 Allen & Heath Limited. All rights reserved

Whilst we believe the information in this guide to be reliable we do not assume responsibility for inaccuracies. We also reserve the right to make changes in the interest of further product development.

ALLEN & HEATH

Allen & Heath Limited
Kernick Industrial Estate, Penryn, Cornwall, TR10 9LU, UK

<http://www.allen-heath.com>



Important Safety Instructions – Read First

- Read instructions:** Retain these safety and operating instructions for future reference. Heed all warnings printed here and on the console. Follow the operating instructions printed in this User Guide.
- Do not open:** There are no user serviceable parts inside. Refer any service work to competent technical personnel only.
- Power sources:** Connect the console to mains power only of the type described in this User Guide and marked on the rear panel. The power source must provide a good ground connection.
- Power cord:** Use the power cord with sealed mains plug appropriate for your local mains supply as provided with the console. If the provided plug does not fit into your outlet consult your service agent. Route the power cord so that it is not likely to be walked on, stretched or pinched by items placed upon or against it.
- Grounding:** Do not defeat the grounding and polarisation means of the power cord plug. Do not remove or tamper with the ground connection in the power cord.
- Ventilation:** Do not obstruct the ventilation slots or position the console where the air flow required for ventilation is impeded. If the console is to be operated in a rack unit or flightcase ensure that it is constructed to allow adequate ventilation.
- Moisture:** To reduce the risk of fire or electric shock do not expose the console to rain or moisture or use it in damp or wet conditions. Do not place containers of liquids on it which might spill into any openings.
- Heat:** Do not locate the console in a place subject to excessive heat or direct sunlight as this could be a fire hazard. Locate the console away from any equipment which produces heat such as power supplies, power amplifiers and heaters.
- Environment:** Protect from excessive dirt, dust, heat and vibration when operating and storing. Avoid tobacco ash, drinks spillage, and smoke, especially that associated with smoke machines.
- Handling:** To prevent damage to the controls and cosmetics avoid placing heavy objects on the control surface, scratching the surface with sharp objects, or rough handling and vibration. Protect the controls from damage during transit. Use adequate packing if you need to ship the unit. To avoid injury to yourself or damage to the equipment take care when lifting, moving or carrying the unit.
- Servicing:** Switch off the equipment and unplug the power cord immediately if it is exposed to moisture, spilled liquid, objects fallen into the openings, the power cord or plug become damaged, during lightening storms, or if smoke, odour or noise is noticed. Refer servicing to qualified technical personnel only.
- Installation:** Install the console in accordance with the instructions printed in this User Guide. Do not connect the output of power amplifiers directly to the console. Use audio connectors and plugs only for their intended purpose.



Important Mains Plug Wiring Instructions

The console is supplied with a moulded mains plug fitted to the AC mains power lead. Follow the instructions below if the mains plug has to be replaced.

The wire which is coloured Green/Yellow or Green must be connected to the terminal in the plug which is marked with the letter E or with the Earth symbol.

This appliance must be earthed.

The wire which is coloured Blue or White must be connected to the terminal in the plug which is marked with the letter N.

The wire which is coloured Brown or Black must be connected to the terminal in the plug which is marked with the letter L.

Introduction

Welcome to the Allen & Heath **PA Series** professional audio mixing system. This user guide describes the functions of the powered **PA-CP** models and also provides tips and reference information to help you get the best from your system. We know you want to get started right away. For this reason we have kept the guide concise and to the point. We recommend you read it through first. However, if even that is too much then at least read the QUICK START page before you plug up and go. For further information on the basic principles of audio system engineering and mixing technique please refer to one of the specialist publications available from bookshops and audio equipment dealers. Further training is available using the many seminars and courses available in audio engineering and related subjects.

We are able to offer further product support through our world-wide network of approved dealers and service agents. You can also access our Web site on the Internet for full company and product information. To help us provide the most efficient service please keep a record of your console serial number, and date and place of purchase to be quoted in any communication regarding this product.

The guide is structured for all levels of user. A brief description of the controls and technical reference information is available for experienced engineers who want to get started quickly. For those of you who want to learn more about the basics of live sound engineering we have included useful blocks of information and tips.

Description Control and connector functions are briefly described together with related technical specifications.

 **Information** Where you see this symbol you will find an explanation or background information on a particular topic.

 **Tips for the user** Where you see this symbol you will find tips and information on using a particular function.

 **Warnings** For your own safety and to prevent damage to equipment make sure you read and adhere to all warnings.

Model	
Serial Number	
Place of Purchase	
Date of Purchase	

Contents

Information

Phantom power.....	13
Balanced and unbalanced connections	13
The mic preamp.....	14
The HPF (high pass filter)	14
The mono channel equaliser.....	15
Pre and post-fade aux sends.....	16
Effects sends.....	16
Foldback sends.....	16
The dB fader scale.....	17
The dB explained.....	17
PFL explained	17
The stereo channel equaliser	19
Wet and dry effects signals	20
Effects processing engines	22
AFL explained	24
Gain structure.....	24
Sub bass speakers	25
The amplifier design philosophy	26
Constant power explained.....	26
Front-of-house and foldback monitors.....	27
Different amplifier configurations.....	27
Why the parametric output equaliser	27
TRS jack	28
Line level.....	28
Impedance balanced outputs	28
SPDIF explained.....	30

Tips for the user

Working with different channel sources.....	13
Setting the channel gain.....	13
Using the HPF (high pass filter)	14
Using the channel equaliser	15
Using more than one effects unit	16
Setting up a foldback monitor mix	16
Using channel pan.....	17
Using the channel faders.....	17
Using PFL.....	17
Using the stereo channels.....	18
Mixing two stereo signals into the channel.....	18
Sending ST1 (3) direct to LR	18
Using the stereo channel equaliser.....	19
Effects in the monitors	21
Using the FX channel PFL	21
Using the effects	22
Checking the gain structure	24
Using PFL and AFL.....	25
Using the AB output equalisers.....	27
Using line level signals	28
Using balanced or unbalanced connections.....	28
Working with powered speakers	29
Choosing headphones	29
Connecting SPDIF	30
Patching in speaker processors.....	30
No amplifier output?	31
How to check speaker polarity	31

Main Topics

Important Safety Instructions	3
Overview.....	6
The PA Range.....	7
Key Features.....	7
Panel Layout.....	8
Quick Start.....	9
Installing the Console.....	10
Mains Power and Earthing	11
Cable and Connector Information... ..	12
The MONO Channel	13
The Mono Equaliser	15
The STEREO Channel	18
The Stereo Equaliser	19
The EFFECTS Channel	20
MIDI and the Effects	23
The MASTER Controls.....	24
The AMPLIFIERS	26
Amplifier Source Select.....	27
AB Output Equaliser	27
The MASTER Connectors	28
Specifications	32
System Block Diagram.....	33
Fitting the PA12-CP Rack Ears.....	34
Cue Sheet.....	35

Overview

PA Series consoles provide all the tools you need to run a small PA system in an easy 'walk up and go' format. You simply plug in your microphone and line sources and connect to the speakers. All the control and processing you need to run a small PA system is built into the console.

Two powered models are available. The **PA12-CP** has 8 mono and 2 dual stereo channels. The **PA20-CP** has 16 mono and 2 dual stereo channels. Both are portable and include protective side trims and front carry handles. The **PA12-CP** can be mounted in a standard 19" rack or plinth by removing its trims and fitting optional rack ears provided.

The two amplifiers can be configured in several different ways according to your PA requirements. For example, you may run a stereo house system without monitors, or a mono system with additional musicians monitor speaker, or you may connect to externally powered house speakers and use the internal amplifiers for two independent monitor speakers. The additional mono line output can be used, for example, to feed a sub bass amplifier/speaker system or another listening zone.

The power amplifier is without doubt the most critical device in the audio signal path. It converts a reservoir of power derived from the mains supply into amplified sound. The **PA-CP** amplifier is a third generation design that has been rigorously field tested both for absolute reliability and sound quality. It uses a solid, no-nonsense 1.6kW linear power supply and bi-polar assisted MOSFET Class AB amplifier design. The unique Allen & Heath constant power system ensures that all the available power is converted into useable speaker power so achieving the full 500W per side into 4 ohms or 8 ohms. Full protection is provided including isolating relays, short circuit and over current protection, output sensing clip limiter, and twin fan thermal management.

We recognise the importance of accurate equalisation both for creative sound processing and for dealing with problems such as feedback and room resonance. The channel strip features a powerful 4 band EQ with two mids, one with swept frequency. We have chosen to include 4 band semi-parametric rather than traditional graphic EQ on the amplifier channels. These provide far greater accuracy and therefore less colouration of the sound. Our 'EQ Visualiser' software is available to help you learn how the parametric controls affect the frequency response.

Years of designing mixers and listening to our customers has resulted in a control surface that presents a well thought out set of functions including many innovative touches that make the job of mixing a simple pleasure. Notable features include individual phantom power, space saving dual stereo inputs, standby and BGM (background music) modes, built-in digital effects processor, lamp connector, selectable sub filter, recording source selector and even an SPDIF digital output.

The name Allen & Heath is well regarded in the professional audio world. The standards applied to our top end consoles also apply to the **PA Series**. High grade circuits and components, 100mm Alps faders, individual vertical circuit cards with sealed potentiometers nutted to the panel, solid grounding with internal copper buss and steel chassis construction are just a few of the qualities that put this powered mixer into a class of its own. Our objective was to provide a truly professional solution for small system mixing. We hope you enjoy using your **PA Series** console.

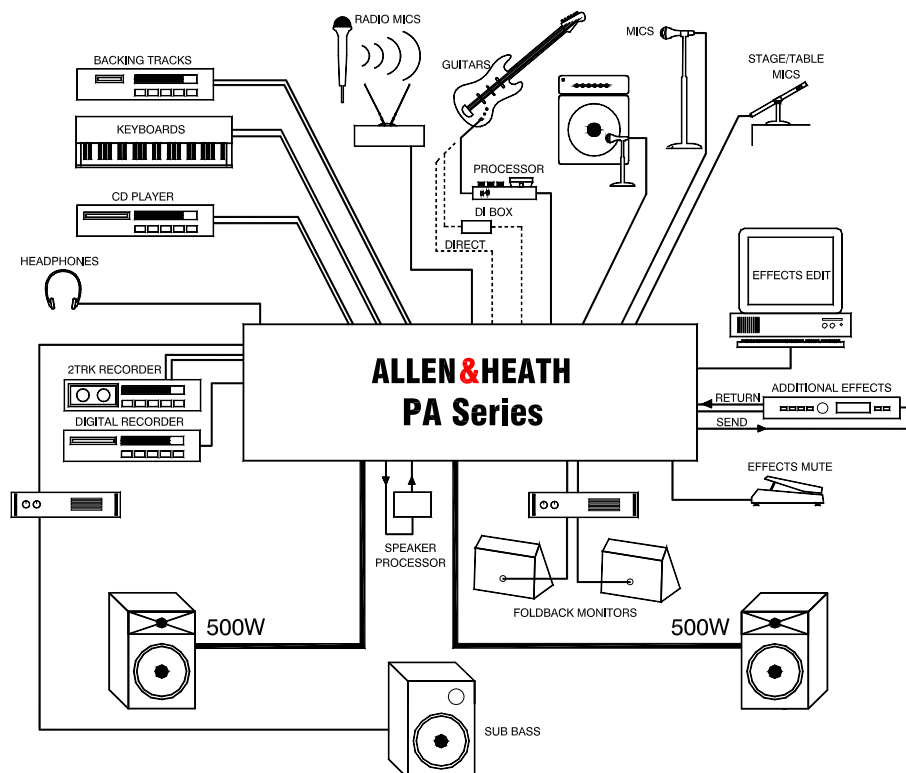

The Range

PA20-CP

16 mono MIC/LINE channels
2 dual stereo LINE channels



PA12-CP

8 mono MIC/LINE channels
2 dual stereo LINE channels



Both Models

LR main output
Mono output summed from LR
4 Auxes – 2 pre-fade foldback, 1 post-fade aux, 1 post-fade effects
External stereo effects input to sum with internal effects
AB amplifiers with slave output and amplifier breakpoint inputs
2-Track input for monitor and BGM replay
2-Track recording with analogue and digital SPDIF outputs
Headphones monitor

Key Features

- Constant power amplifier for 2x 500W into 4 or 8 ohms
- Semi-parametric output EQ for more accurate frequency control
- 4 Band channel EQ with swept high mid and 250Hz low mid
- Built-in stereo digital effects with external summing and MIDI control
- SPDIF digital audio output
- Dual stereo channels for summed or 4 independent inputs
- Standby and post-LR BGM operating modes
- Switchable sub bass filter on mono output
- Individual +48V phantom power switching
- 100mm faders, mutes and inserts throughout

Accessories

Rack Ears

A pair of metal ears to replace the trims and fix the console into a 19" rack or custom furniture.

PA EQ Visualiser

Runs on a PC to display how the parametric output EQ affects the frequency response



AL4061 Lamp

Plug-in XLR gooseneck lamp to illuminate the control surface

5

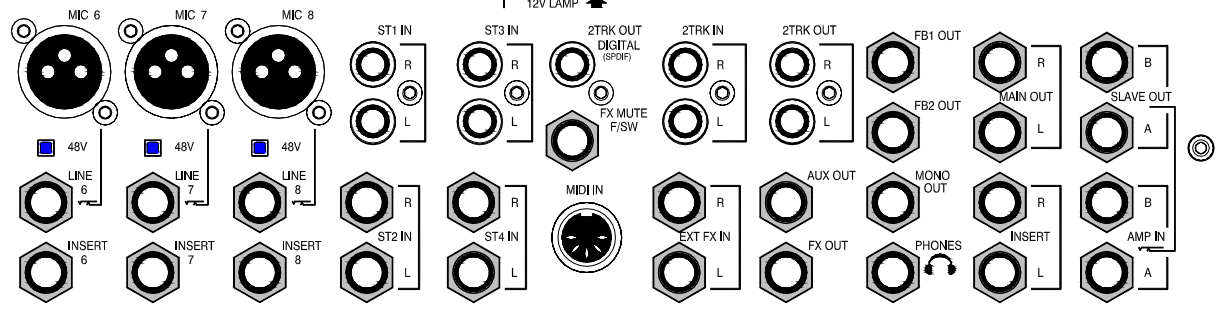

Main control panel for channels 6, 7, 8, 9-10, and 11-12. Each channel has a gain knob, a 100Hz filter, and three frequency sliders (HF 12kHz, HM 350Hz, LM 250Hz, LF 60Hz). Channel 9-10 and 11-12 have ST1-4 gain knobs. Each channel also has feedback (FB1, FB2), auxiliary (AUX), and effects (FX) knobs, as well as pan (PAN) and balance (BAL) controls. Mute and PFL (Peak Filter Lock) buttons are provided for each channel.

Parametric output equalizer section with two sections, EQ A and EQ B. Each section has three frequency sliders (LF, HM, HF) and a level knob. There are also gain knobs and a limiter (LIM) control. The EQ is used to shape the frequency response of the output.

ALLEN&HEATH

FX control section featuring a gain knob, an external FX knob, and two internal FX knobs (FB1, FB2). The internal FX knobs are used to select and control various effects.

- | REVERB | EFFECTS |
|----------------------------------|------------------------------------|
| <input type="checkbox"/> HALL 1 | <input type="checkbox"/> DELAY 1 |
| <input type="checkbox"/> HALL 2 | <input type="checkbox"/> DELAY 2 |
| <input type="checkbox"/> ROOM 1 | <input type="checkbox"/> CH / RM 1 |
| <input type="checkbox"/> ROOM 2 | <input type="checkbox"/> CH / RM 2 |
| <input type="checkbox"/> ROOM 3 | <input type="checkbox"/> CHORUS |
| <input type="checkbox"/> PLATE 1 | <input type="checkbox"/> FLANGER |
| <input type="checkbox"/> PLATE 2 | <input type="checkbox"/> ROTARY |
| <input type="checkbox"/> PLATE 3 | <input type="checkbox"/> PHASER |

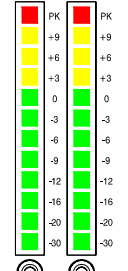

PA12-CP CONSTANT POWER

Output section including a standby button, a mono out knob, and two stereo outputs (2TRK OUT L/R). There are also phones and PFL/AFL buttons. The section is labeled PA12-CP CONSTANT POWER.

Mute, AFL, and level meters for feedback (FB1, FB2) and stereo (L, R) channels. Each channel has a mute button, an AFL button, and a level meter with a color-coded bar (black, red, yellow).

3

7

Quick Start ►►

- 1 Ensure your safety** First read and understand the Important Safety Instructions printed earlier. Make sure that all your equipment is set for your local mains supply voltage and correctly grounded to ensure your safety. Check that the console rear panel ON/OFF switch is in its out position (off). Plug in the mains power using the power cord supplied with the console. Do not turn anything on until you have checked your wiring and control settings. Also make sure the ventilation slots on the front and rear are not obstructed in any way.
- 2 Set all controls to their starting position** Set the AMPLIFIER levels, channel FADERS, GAINS, FB, AUX and FX sends, MONO OUT and 2TRK to LR level controls minimum (anti-clockwise). Set PAN and all EQ controls centre. Set all switches up or out. Make sure the 48V switches next to the MIC inputs are in the up position. Check that the recessed panel switches are up (flush with the panel). Use a pen or pointed object to operate these. Starting with the controls set in this way prevents any unexpected surprises when you switch the system on.
- 3 Configure the system** Decide how you wish to use the amplifiers. Set the AMP A and B source switches for stereo, mono + monitor, or 2x monitor operation. These switches are recessed to avoid accidental operation once set. A good starting point is the default stereo operation (both switches up).
- 4 Connect the loudspeakers** Check that the loudspeaker cables are correctly connected at the speaker end. Plug your speakers into the rear panel A and B Speakon™ connectors. Push the plugs into the sockets and twist them into their locked position. Use 4 ohm or 8 ohm speakers. Do not use bridged operation. Set the rear panel CONSTANT POWER slide switch to the correct position for the speakers used.
- 5 Plug in a music source** Plug a CD player or similar test source into the ST3 inputs on the last stereo channel. Check that the recessed switch below its GAIN control is flush with the panel. This routes the ST3 input to the stereo channel.
- 6 Turn the system on** Press the ON/OFF switch to apply power to the console. The front panel blue power LED lights and you should hear the speaker relays click in after one or two seconds. You may also hear air movement as the internal fans start up. The meters and several other LED indicators may pulse as the power rails stabilise. This is quite normal.
- 7 Adjust the levels and route the signal to the outputs** Press the stereo channel PFL button. Adjust the ST3 GAIN control until the main meters read around '0'. Release PFL and raise the channel and LR faders to their '0' positions. Next, gradually raise the AMP A and B LEV trim controls. You should hear the music in the speakers. With the meters averaging '0' to '+6' adjust the amplifier LEV trimmers for the loudest volume you expect from the system. That gets the gain structure about right.
- 8 Experiment with the system** Use the music source to experiment with the EQ and internal effects. Plug a microphone into one of the mono channels. Make sure the channel is muted when you plug or unplug microphones, or when you switch 48V phantom power on or off. To find out more about each control continue to read through the rest of this guide. **HAPPY MIXING !**



Important Note about Hearing : To avoid damage to your hearing do not operate any sound system at excessively high volume. This also applies to any close-to-ear monitoring such as headphones and IEM. Continued exposure to high volume sound can cause frequency selective or wide range hearing loss.



Installing the Console

The **PA Series** is portable and designed for stand alone operation. The smaller **PA12-CP** model can also be 19" rack mounted by replacing the trims with the rack ears provided. Either way, ensure adequate ventilation around the unit and heed all warnings regarding mains power safety and earthing.

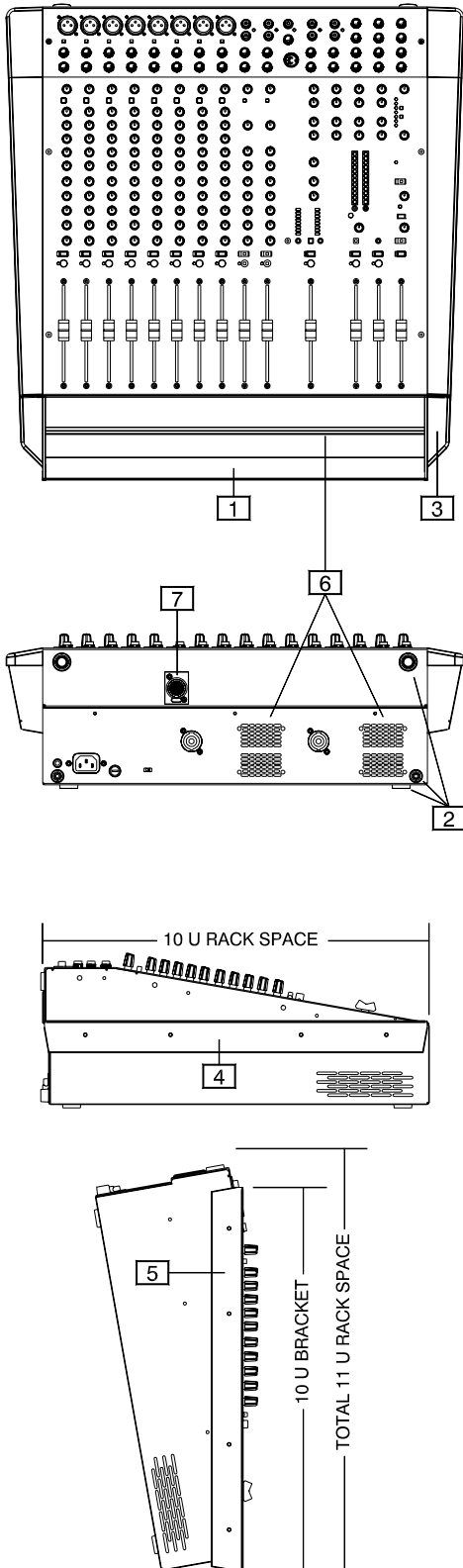

1 Carry Handle Metal handle for lifting and carrying the console. The weight is centrally distributed. Lift the console by holding the handle securely in the middle. To prevent damage to the controls, carry it with the control surface away from you.

⚠ The console is necessarily heavy due to the high power amplifiers built in. To avoid injury to yourself or damage to the equipment always ensure you are correctly positioned and grip securely when lifting, moving or transporting the unit.

2 Feet Protective rubber feet are fitted to both the base and the rear of the console so that it can be positioned for stand alone operation or on the floor while it is being carried. This avoids damage to the mounting surface and console parts.

3 Front and Side Trims The front armrest, carry handle and side trims offer both protection and style to the console. They can be easily removed for fitting the metal ears provided when you want to permanently mount the console in a 19" rack or plinth. This option only applies to the smaller **PA12-CP** model. Instructions for fitting the rack ears is provided later in this user guide. The console can be rack mounted in either of two positions as described below.

4 Rack Position 1 Shows the ears fitted for top of rack mounting. The controls are angled upwards above the rack for easier access during operation. This position may also be preferred when the console is mounted in a desk or other furniture. 10U rack space is required. Allow additional space for access to the rear panel connectors.

5 Rack Position 2 Shows the ears fitted for front of rack mounting. The controls are flush with the rack and connectors angled slightly back. 11U rack space is required. This allows space for cables to be routed into the rack, and for the console lamp to be accessed.

6 Ventilation and Cooling The console uses a twin fan thermal management system to control the operating temperature of the built-in 1kW power amplifiers. Air is drawn in from the front and expelled from the rear. The fans run at low speed when cool, medium speed on reaching 35 degrees C, and fast speed at 50 degrees C. The unit shuts down safely in thermal protect mode in the unlikely event that excessive temperature is reached.

⚠ Do not obstruct the front or rear ventilation slots or position the console where air flow required for ventilation is impeded. The console must not be operated in any carry or flight case that obstructs these slots. Ensure adequate air flow when rack or plinth mounting the console.

7 Console Lamp Plug in a 4-pin XLR 12V gooseneck lamp designed for this purpose. The right angled type is recommended. A low or high intensity bulb up to 400mA maximum can be used. Only one lamp may be connected.

Mains Power and Earthing

Connecting Mains Power Read the SAFETY INSTRUCTIONS printed at the front of this user guide and on the rear panel. The power supply is wired for the local voltage required. Check that the correct mains lead with moulded plug has been supplied with your console, and that the marked voltage matches your local supply. Ensure that the IEC mains plug is pressed fully into the rear panel socket before switching on.

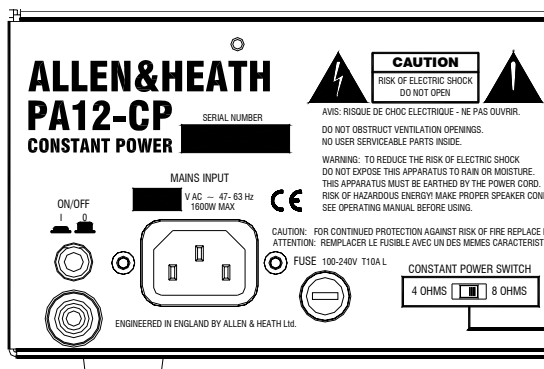

⚠ To avoid any unexpected audible clicks or thumps turn connected power amplifiers down or off before switching the console or any other signal equipment on or off. The built-in amplifiers include an automatic turn on delay for this purpose.

Switching On Press the rear panel ON/OFF switch in. The front panel blue power LED lights. You should hear the speaker relays switching in after a second or two. This avoids audible thumps while the circuits stabilise. The front panel SPK OFF indicators light while the speakers are isolated. You may also hear air movement as the internal fans start up. The meters and several other LED indicators may pulse briefly. This is quite normal.

Switching Off Release the rear panel ON/OFF switch. The relays switch off instantly to protect the speakers from any switch off thumps.

Earthing The connection to earth (ground) in an audio system is important for two reasons: SAFETY to protect the operator from high voltage electric shock, and AUDIO PERFORMANCE to shield the audio from interference.

For safety it is important that all equipment earths are connected to mains earth so that exposed metal parts are prevented from carrying high voltage which can injure or even kill the operator. It is recommended that the system engineer check the continuity of the safety earth from all points in the system including microphone and instrument metal, equipment cases, rack frames, and so on.

The same earth is also used to shield audio cables from external interference such as the hum fields associated with power transformers, lighting dimmer buzz, and computer radiation. Problems arise when the signal sees more than one path to mains earth. An 'earth loop' (ground loop) results causing current to flow between the different earth paths. This condition is usually detected as a mains frequency audible hum or buzz.

To ensure safe and trouble-free operation we recommend the following:

- **Have your mains system checked by a qualified electrician** If the supply earthing is solid to start with you are less likely to experience problems.
- **Do not remove the earth connection from the console mains plug** The console chassis is connected to mains earth through the power cable to ensure your safety. Audio 0V is connected to the console chassis internally.
- **Deal with ground loops** Should you experience hum or buzz caused by earth loops, check first that each piece of equipment has its own separate path to earth. If so, operate earth lift switches on connected equipment in accordance with the instruction manuals. Alternatively, disconnect the cable screen at the destination end only. This breaks the offending loop while still maintaining the signal shielding down the length of the cable.
- **Use low impedance sources** such as microphones and line level equipment rated at 200 ohms or less to reduce susceptibility to interference. For high impedance instruments use DI (direct inject) boxes such as those readily available from most music equipment suppliers. The console outputs are designed to operate at very low impedance to minimise interference problems.
- **Use balanced connections for the microphone inputs and main outputs** as these provide further immunity by cancelling out interference that may be picked up on long cable runs. Refer to the cable diagrams for details on how to connect balanced and unbalanced equipment.
- **Route cables to avoid interference** To avoid interference pickup keep audio cables away from mains power units and cables, thyristor dimmer units or computer equipment. Where this cannot be avoided, cross the cables at right angles to minimise interference.
- **Use good quality cables and connectors** and check for correct wiring and reliable solder joints. Use the correct cable type. Allow sufficient cable loop to prevent damage through stretching.

If you are not sure ... Contact your service agent or local Allen & Heath dealer for advice.

Cable and Connector Information

You are likely to encounter the following audio connector types:

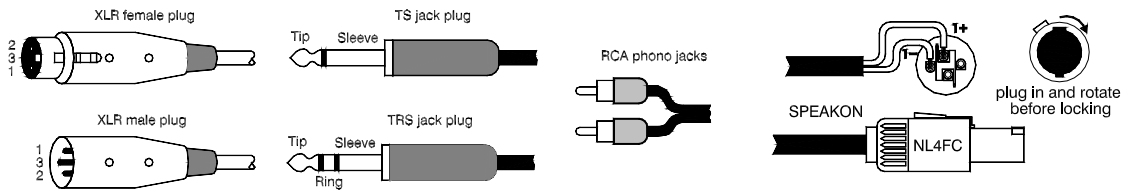

The **XLR** connector is 3 wire balanced. This has 3 connector pins: Pin 1 = ground (screen), Pin 2 = signal hot (+), Pin 3 = signal cold (-). The jack sockets are the 3 pole **TRS** type. These are wired to work with either the balanced TRS or the unbalanced 2 pole TS type plugs without cable modification. The sockets have 3 connector pins: Inputs and outputs are Tip = signal hot (+), Ring = signal cold (-), Sleeve = ground (screen). Headphones are Tip = left, Ring = right, Sleeve = ground. The **RCA** phono connectors are 2 wire unbalanced to connect to equipment such as CD players and domestic amplifiers. The **Speakon™** connector type is used to feed the output of power amplifiers to the loudspeakers. It can handle high power levels and can be locked into position.

To ensure best performance, we recommend that you use high quality audio cables and connectors, and take time to check for reliable and accurate cable assembly. It is well known that many audio system failures are due to faulty interconnecting leads. Avoid reversing + and - on balanced and speaker cables as this will result in reverse polarity connections which may cause signal cancellation and 'phasing' effects. Refer to the diagram below for how to wire unbalanced to balanced connections. **It is fine to use a Y-adapter to feed one output to several inputs, but never use a Y-adapter to sum two outputs into one input.**

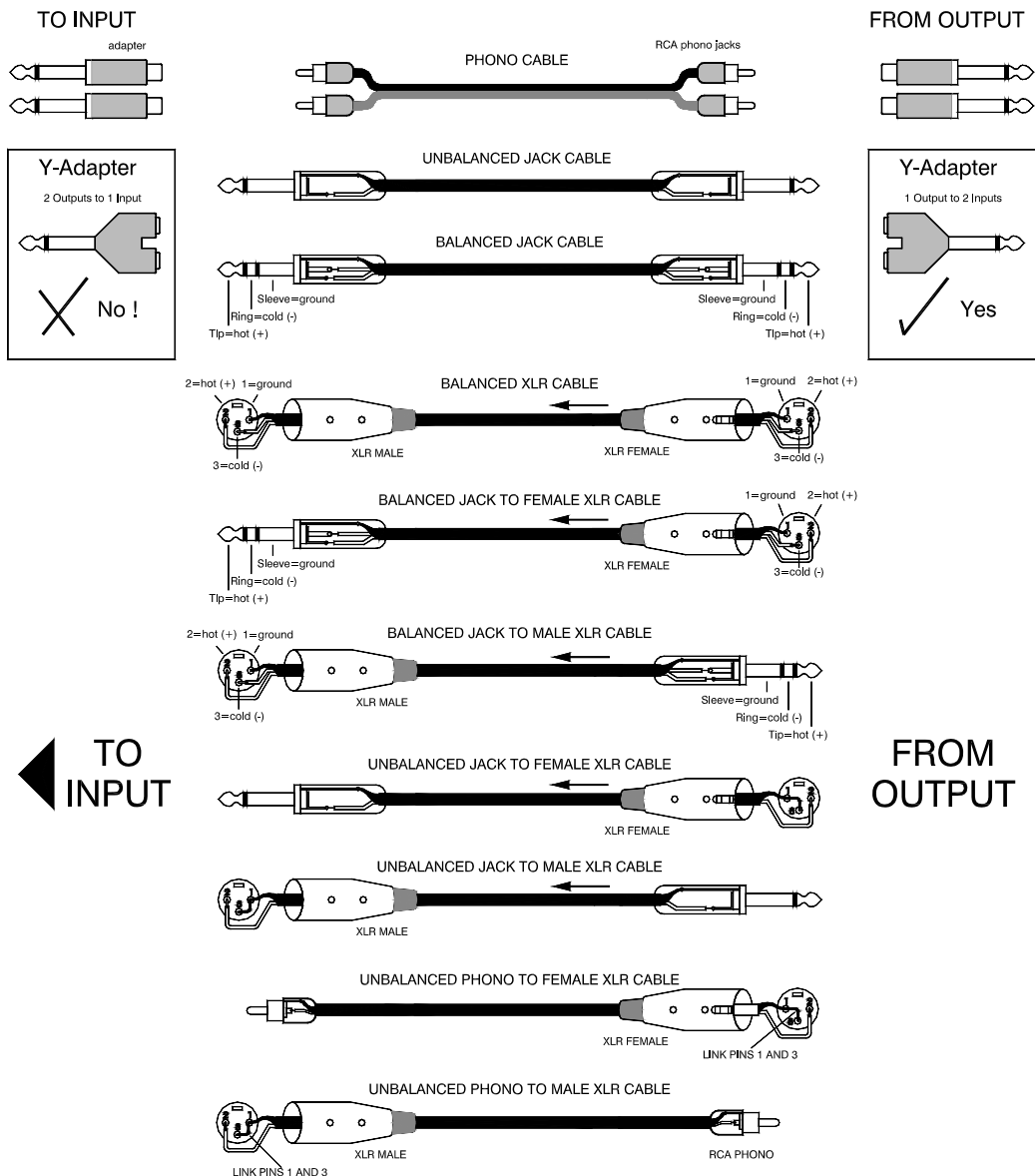

The MONO Channel

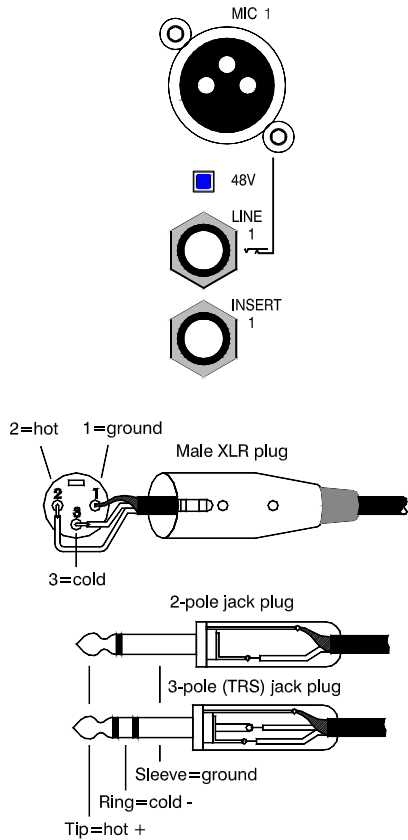

i Balanced and unbalanced connections

An unbalanced connection uses two cable wires, signal and ground (screen). A balanced connection uses three wires, signal + (hot), signal - (cold) and ground (screen). The balanced connection has the advantage that it rejects noise and interference that may be picked up on long cable runs. Here is how it works: The audio signal is sent at equal level but opposite polarity on the + and - wires. The - signal gets inverted and adds to the + signal at the receiving end. However, any interference picked up by the cable is injected equally into both the + and - wires and therefore cancels out at the receiving end where the interference on the - wire is inverted.

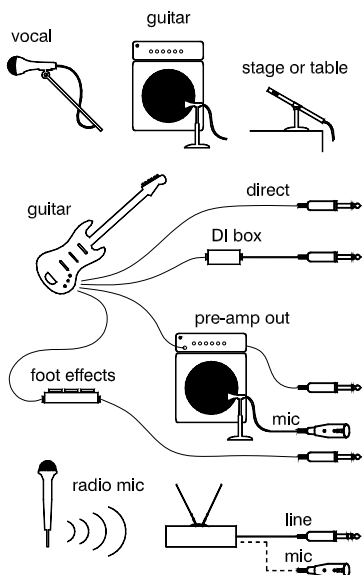

MIC INPUT XLR input for connecting microphone level signals in the range -63 to +5dBu. These are balanced and wired pin 2 hot. Use low impedance microphones (less than 600 ohms) and professional grade mic cables (2 core with shield) for best performance. You can also use these inputs with DI boxes and other low level sources.

48V Phantom Power Press this switch if the microphone needs phantom power. Some active DI boxes may also require power. Check the manufacturers specification regarding power requirements. If phantom power is not required leave the switch in its up position.

⚠ WARNING Do not connect unbalanced sources or cables to the XLR inputs when phantom power is applied. No damage will be done to non powered balanced microphones as long as balanced cables are used.

⚠ To avoid loud clicks always mute the channel before plugging or unplugging phantom powered inputs.

i **Phantom Power** is so called because the DC voltage required to power certain microphones is sent down the same wires as the audio signal. It is applied equally to the + (hot) and - (cold) signal wires through closely matched 6.8kohm resistors. The power is tapped off from both signal wires at the microphone end where it is used to power a little booster amplifier circuit or energise the transducer. The audio signal does not 'see' the phantom power. This is because the voltage is the same on both the signal + and - wires and cancels out at the differential console input. This would not be the case if an unbalanced cable was used. For this reason phantom power must only be used with balanced sources.

LINE INPUT TRS input for connecting line level signals in the range -25 to +10dBu. The input is balanced but can be used with both balanced or unbalanced sources as shown in the cable diagrams. Plugging into the line input automatically overrides the mic input.

⚠ Do not use Y-adaptors to combine stereo L and R signals such as those from a CD player into one input. Use the stereo or two mono channels for stereo sources.

⚠ Do not plug amplifier speaker outputs into the console line inputs. Use a DI box with speaker level input if you need to do this.

😊 Working with different sources Choose your microphones carefully according to their application. Low impedance balanced types are recommended in all cases. Dynamic mics are well suited to hand held vocal or general instrument work. Condensers can provide greater accuracy but may not be as rugged. Boundary mics work well for ambient pickup such as front of stage floats or conference tables. Rifle mics are very directional and best used for distant pickup such as across a stage. It is best to use a directional mic pattern such as cardioid in live situations where feedback may be a problem. Make sure phantom power is not selected when plugging in radio mic receivers. A guitar can be plugged in directly only if using a short cable. For long cable runs you should use a DI box which converts it to balanced mic signal. A popular practice is to use a microphone placed in front of the guitar amplifier. This captures the sound heard by the musician.

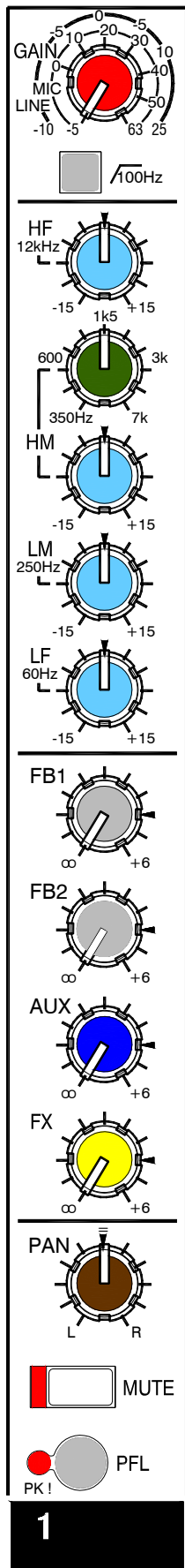

GAIN Adjusts the sensitivity of the channel preamp to match the connected source to the 0dBu operating level of the console. The control has a very wide range matching mic levels from a low -63dBu (0.5mV) to a high +5dBu (1.5V), and line levels from -25dBu (45mV) to +10dBu (2.5V).

The mic preamp is probably the most important stage in the console signal path. Its performance is often the measure of how good the console is. The **PA Series** uses a high grade dual stage design developed from our top end consoles. The mic input passes through both stages for increased gain range and correct matching to low impedance microphones. The line input passes through the second stage only, so ensuring very low noise and high impedance for matching to a wide range of instruments and equipment. Plugging into the line input TRS jack breaks the signal path from the first stage. This overrides the mic input.

Setting the gain Use the channel PFL function to view the signal level on the console meters. Adjust the gain control for average signal level around meter '0' with loudest peaks no more that '+6'. If you see the channel PEAK indicator flash back the gain off a little.

100Hz HPF Switches in the high pass filter which attenuates very low frequencies. Use this to reduce mic handling noise and 'popping', stage rumble and bleed through from other low frequency sources.

The HPF is a second order design with 100Hz cut off frequency and 12dB/octave slope. This means that it is 3dB down at its 100Hz cut off point and reduces the frequencies below that by 12dB every octave (halving of frequency).

Using the filter The high pass filter is an invaluable tool for cleaning up the mix. The majority of live sound sources have very little content below 100Hz. Modern microphones have wide frequency response and can pick up bleed from nearby low frequency sources such as bass and kick drum even though they are placed on other instruments or voices. For example, switch the filter in on vocal channels to reduce mic handling noise and close proximity 'popping', on drum overhead mics to reduce kick and bass pick up, on higher frequency instruments such as flute and acoustic guitar, on stage mics to reduce foot noise, and so on.

INSERT Lets you patch external processing equipment such as a compressor or noise gate into the channel signal path. Plugging in interrupts the signal path after the 100Hz filter and before the EQ. With nothing plugged in, the signal is routed through the normal contact within the socket. The connection is unbalanced with both the insert send and return signals presented on the same jack. Connect the equipment input from the send (TRS jack tip), and its output to the return (jack ring). Wire the cable shield to the jack sleeve. The insert operates at 0dBu line level. Ensure that the external equipment is set to operate at similar level and unity gain. The diagram below shows a typical insert cable with plug links to unbalance the external equipment connections.

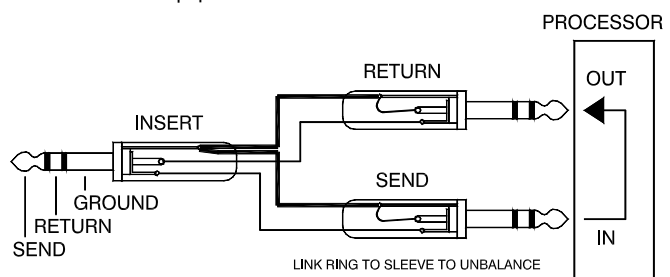

BASS TREBLE

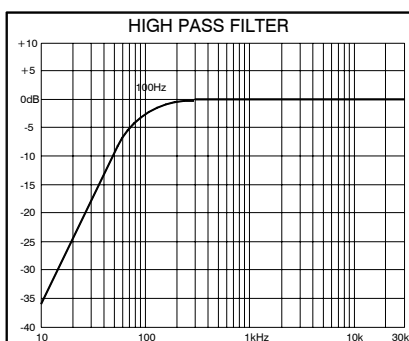
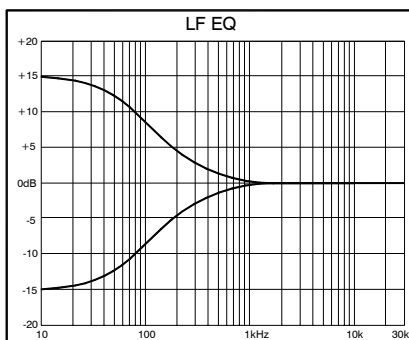
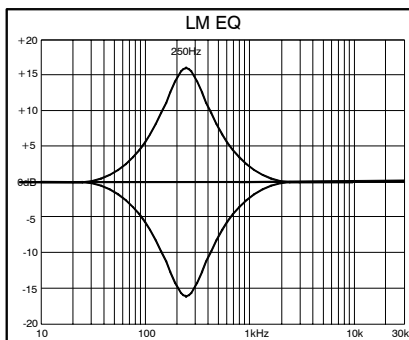
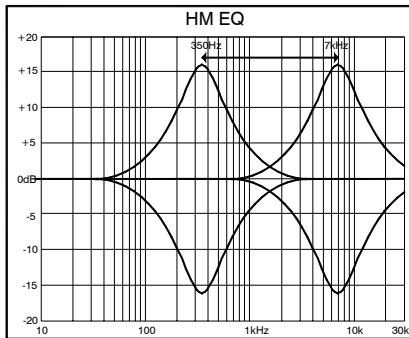
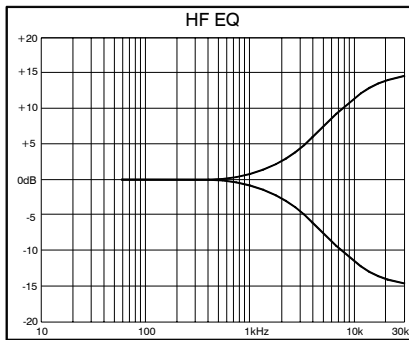

EQUALISER The channel equaliser allows independent adjustment of four frequency bands. This lets you accurately pinpoint the frequencies you want to adjust to deal with problems such as feedback or instrument resonance, or to creatively tailor the sound.

HF The high frequency band has a shelving response that cuts or boosts the higher (treble) frequencies by up to 15dB. It has most effect from 12kHz and higher.

HM The high mid band has a bell shaped peak/dip response that cuts or boosts the higher mid frequencies by up to 15dB. The centre frequency can be swept from 350Hz to 7kHz letting you tune in to the frequency you want to adjust. $Q = 1.8$.

LM The low mid band has a similar bell shaped response that cuts or boosts the lower mid frequencies centred on 250Hz. This control is useful in dealing with boomy sounds, or adding low end warmth. $Q = 1.8$.

LF The low frequency band has a shelving response that cuts or boosts the lower (bass) frequencies by up to 15dB. It has most effect from 60Hz and lower.

i **The EQUALISER** featured in the **PA Series** is a semi-parametric type similar to those found in top end live sound consoles. The four band design provides frequency control far more powerful than that found in most competitive consoles. The +/- controls allow precise level adjustment of each band up to 15dB (4.5 times). The LF and HF bands have a shelving response which gradually increases or decreases the level at each end of the frequency spectrum until a maximum shelf level of 15dB is reached. The mid bands have a bell shape around their centre frequencies. The width of the bell is referred to as its 'Q' factor. This is calculated from the centre frequency divided by frequency range between the points either side where the level drops 3dB. The larger the value, the tighter the bell.

😊 Using the equaliser It is best to keep the adjustments made using the equaliser as small as possible. Use the microphones best suited for the application and ensure they are positioned carefully for optimum pickup. Starting with good sources makes the job of mixing much easier. To learn about the equaliser play a good quality pre-recorded music source such as CD through a mono channel. Start with the controls set flat (mid position). Boost and cut each band in turn listening how it affects the sound. With HM boost and cut listen to the effect of turning the frequency control. The more familiar you become with how different frequencies sound the quicker you will be able to find and tune out resonant or ringing frequencies, or enhance the tone creatively.

During sound check first set the channel gain to match the source. Do this using the PFL function. Select the 100Hz filter where appropriate. Start with the EQ flat then adjust its controls to get the sound you want. Try not to apply too much boost. Cut rather than boost where possible. Make gradual adjustments to avoid feedback or unexpected surprises. If the channel PEAK indicator flashes then turn back the gain control.

The EQ can be used to creatively enhance or correctively improve the tonal quality of each sound in the mix. For example, you could use HM to brighten up a guitar so it stands out in the mix, LM to cut back the boominess of a kick drum while using HM to enhance the snap of its beater, HF to add some 'air' to a flute or to cut back a hissy keyboard, LF to add some depth to sound effects, and so on. Tuning and cutting HM can be very effective in notching out a ringing mic frequency to help increase its gain before feedback.

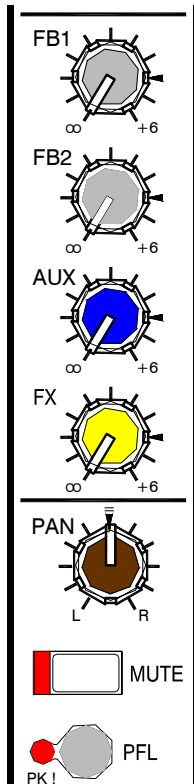

1

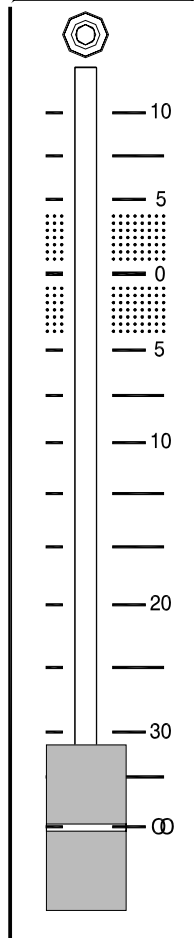

AUX SENDS The **PA Series** has four auxiliary sends. These provide independent mixes from the channels. They have many applications, the most common being foldback monitor and effects sends. They can also be used for additional special feeds such as recording or clean feed.

FB1 Pre-fade aux send feeding the FB1 foldback monitor output. Turn up the control to send the channel signal to the mix, from fully off to a maximum +6dB boost. The unity 0dB position is indicated. The send is pre-fader but post-EQ and post-mute. This means that its level is not affected by the channel fader but it is affected by any changes made to the EQ. Pressing MUTE also turns off the FB1 send.

FB2 Pre-fade aux send feeding the FB2 foldback monitor output. Similar to FB1 described above.

AUX Post-fade aux send feeding the AUX output socket. The AUX send is affected by the channel fader. The AUX mix can be used for a variety of applications such as additional effects send, independent speaker zone or recording feed.

FX Post-fade aux send to the internal effects unit and also the FX output socket. Turn up the control to feed a portion of the channel signal to the effects unit where it is processed to create effects such as reverb and delay. The FX sends let you adjust how much effect you add to each signal in the mix.

i **Aux sends** are referred to as 'pre-fade' or 'post-fade'. This is because the signal that is routed to the send control is sourced before (pre) or after (post) the channel fader. This is illustrated in the BLOCK DIAGRAM in the Specification section later in this user guide.

i **Effects sends** are used to add effects such as electronically simulated reverb or echo to the mix. Turning up the FX control sends a portion of the channel signal to the internal effects unit where it is processed before being returned to the main mix through the FX channel. The processed 'wet' signal adds to the direct 'dry' signal in the same way as the listener would hear a direct sound followed by natural room reverberation. The FX send is post-fader to ensure that the balance between direct and effect signal is always the same regardless of fader position.

😊 **Using more than one effects unit** Use the AUX send to feed another effects processor in addition to the internal effects unit. You can also use the FX output with an external unit instead of or mixing with the internal unit.

i **Foldback sends** are used to provide individual or groups of performers or backstage crew with their own monitor mix, for example wedge speakers facing musicians on stage, in-ear monitors, hotspot speakers, dressing room and lighting position feeds. The mix is created by turning up the channel FB sends according to the needs of the performers. It is not affected by the faders which control what the audience hears.

😊 **Setting up a foldback monitor mix** Start with all the channel sends turned fully down. Gradually turn up the sends to add those sounds requested by the performers, typically the vocals and a few lead instruments. Normal control position is around 9 to 3 o'clock according to strength in the mix. Be careful to avoid feedback between closely positioned mics and speakers. Only add those sounds which are needed or requested. Keep the mix as simple as possible and try to avoid adding effects such as reverb which can muddy the sound on stage and reduce the gain before feedback.

PAN Adjusts the stereo position of the channel signal in the main LR mix. At the centre position equal signal is sent to the L and R outputs. Fully anticlockwise all the signal routes to L and none to R, and fully clockwise the reverse is true. The control has a 3dB attenuation at its centre position. This ensures equal power as the sound is panned from one side through the centre to the other side. It also has a mechanical detent to help you find its default centre position quickly.

 **Using PAN** If you are working with a stereo PA system use PAN to set the position of each signal in the mix. In live sound mixing it is best to set pan centre or close to centre for most signals so that all listeners hear a similar balance regardless of their position in the room. Sounds such as kick drum, bass and lead vocal would usually be set centre. Ambient or backing sources may be panned slightly to spread the image. Stereo sources such as backing tracks, keyboards and sound effects may be panned fully or use the stereo channels instead. If you are working with a mono PA system simply set all pan controls centre.

MUTE Press this switch to turn the channel signal off. The large red LED lights to warn that the channel is muted. Mute affects the channel pre and post-fade sends. This ensures that the feeds to the foldback monitors, effects, aux and house mix are turned off when the channel is muted. It does not affect PFL. You can still use PFL to check the signal while the channel is muted.

 **To avoid loud clicks or unexpected noises always mute the channel before plugging or unplugging microphones and other sources.**

PFL Press this switch to listen to the channel signal in the headphones and display its level on the main meters. This lets you check each channel signal independently without affecting the outputs. PFL is sourced pre-fader, pre-mute. Pressing PFL automatically overrides LR or 2TRK in the headphones. The channel PFL switch LED and the big PFL/AFL indicator below the main meters light to warn that PFL has been selected.

 **PFL** stands for Pre-Fade Listen. It sends the signal taken just before the channel mute switch and fader to the engineers personal headphones monitor and console meters. This means that you can check the signal while the channel is muted or its fader down. Note that AFL, as found on the FB1 and FB2 masters stands for after-fade listen.

 **Using PFL** Use PFL to check sound quality and the channel gain setting when plugging in different sources or when you suspect a change or problem with a particular signal. During sound check start with the channel muted. This lets you set up the signal before you introduce it into the monitors and house mix. Press PFL. You should hear the signal in your headphones and see its level displayed on the console meters. Adjust the gain control so that the meters read an average '0' with loudest peaks no more than '+6'.

PK! The PFL switch LED also provides a channel signal peak indication. The indicator lights brightly when the pre-fade signal reaches +16dBu. This means that it lights 5dB before clipping to give you the chance to reduce the signal before you hear any distortion. If the PK! Indicator flashes turn back the channel gain control until it stops.

FADER A 100mm smooth travel fader adjusts the signal level feeding the main LR mix, AUX and FX sends. It provides up to +10dB boost above its normal unity gain '0' position, and shuts off fully when pulled back to its bottom position.

 **Using the faders** These are your main mixing controls. Use the channel faders to adjust the level of each signal in the mix. Normal operating position for dominant sounds is around the '0' mark, with the quieter backing sounds typically in the range '0' to '-20'. The +10dB boost is there to give you a bit extra when you need it. If you find your normal setting is near maximum fader position or well below '0' then use PFL to check that the gain is correctly set.

 **The fader scale** is graduated in dB (decibel) markings. The dB is a measurement of gain. It relates the fader output level to its input level. If the output is the same as the input then the gain is 0dB. That is why the fader is marked '0' at its normal operating position, the point at which all the channel signal is fed to the mix. If the fader is moved above '0' it produces more output and therefore has gain boosting the signal level up to a maximum of +10dB. As the fader moves below '0' it produces less output than its input and therefore has attenuation. The -5, -10, -20 and -30dB attenuation positions are marked. The infinity mark at the bottom position represents maximum attenuation, in other words the signal is turned off.

 **The dB explained** Because of the way the human ear responds to sound, the decibel uses a logarithmic rather than linear scale. Regarding audio voltages, $\text{dB} = 20\log(\text{Vout}/\text{Vin})$ where Vout is the output level expressed as a voltage, Vin the input level. You can see that 0dB is the result when the Vout is the same as Vin. This is also referred to as 'unity gain', or gain of 1x. For rule of thumb, gain is:

+10dB	=	3x	at fader top
+6dB	=	2x	
0dB	=	1x (unity)	
-6dB	=	0.5x	
-10dB	=	0.3x	
-20dB	=	0.1x	
-30dB	=	0.03x	
-90dB	=	0.00003x	at fader bottom

The above shows how wide the fader control range is. At maximum position the signal is amplified three times. At minimum position it is just 1/30000 of the original, effectively off.

Write-on Block Use the white block for labelling the channel using chinagraph marker, felt pen, adhesive label or tape, or magnetic label strips. Avoid leaving sticky residue. Do not use chemicals or solvents to clean the blocks.

The STEREO Channel

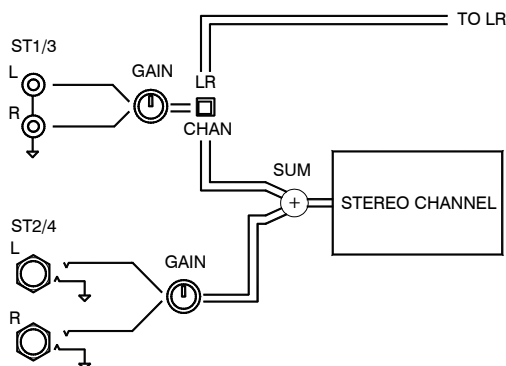
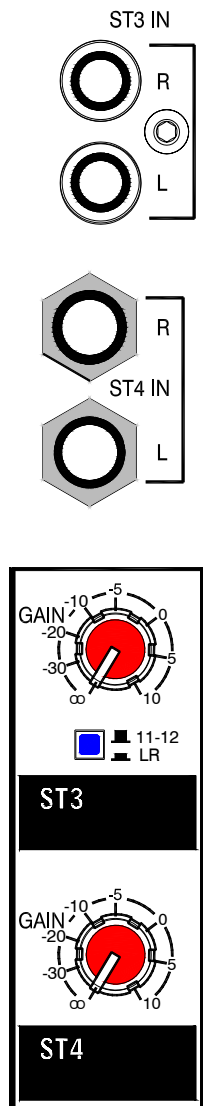

Dual Stereo Inputs Each stereo channel has two independent stereo inputs, ST1(3) and ST2(4). For convenience, one uses RCA phono connectors, the other uses TRS jacks. The two inputs mix together to feed the channel strip, or ST1(3) can be routed direct to the LR mix instead, leaving ST2(4) to feed the channel. This provides a very flexible arrangement for mixing up to four stereo sources.

ST1(3) INPUT RCA phono inputs for connecting line level stereo signals. These connectors are popular with consumer and semi-professional equipment such as tape deck, video camera, computer, CD and MiniDisc players.

ST2(4) INPUT TRS jack inputs for connecting line level stereo signals. The inputs are unbalanced but can also accept balanced sources. The ring connection grounds the -ve (cold) signal to unbalance a connected balanced source. Typical applications include stereo keyboards, voice modules, effects processors and sub mixers.

Using the stereo channels These inputs are intended for local stereo sources. The unbalanced connections work fine with the higher voltage levels and low impedance associated with such equipment. If you need to connect equipment further than 10 metres away we recommend you use the mono channel balanced line inputs or DI boxes feeding the long cables to the mic inputs.

ST1(3) Mode Switch This small switch is recessed to prevent accidental operation once it is set. In its up position it is flush with the panel and mixes the ST1(3) signal with ST2(4) to feed the stereo channel. Use a pen or similar pointed object to press the switch if you want to route the ST1(3) signal direct to the LR mix instead of the stereo channel.

Mixing two stereo signals into the channel (Switch flush with panel). There are many situations where it is convenient to combine two sources into one channel. For example, you may have two MiniDisc players being used for backing tracks or sound effects, a stereo keyboard together with additional MIDI controlled voice module, two effects processors returning into one effects channel, or simply two unrelated sources being used at different times. Use the two GAIN controls to adjust the balance between the sources.

Sending ST1(3) direct to LR (Switch pressed, below panel). Some sources may only require 'set and forget' routing to the main LR mix. For example, an external reverb processor return with its levels mixed using the channel aux sends, or the outputs of a stereo sub mixer with local control of its mix. Routing ST1(3) in this way frees up the stereo channels for other sources. Adjust the level using the ST1(3) GAIN control from fully off to +10dB boost.

GAIN Adjusts the sensitivity of the channel preamp to match the connected source to the 0dBu operating level of the console. The control has a range from fully off to +10dB boost so that sources from -10dBu and higher can be connected.

Setting the gain Use the channel PFL function to view the signal level on the console meters. Adjust the gain control for average signal level around meter '0' with loudest peaks no more than '+6'. If you see the channel PEAK indicator flash back the gain off a little.

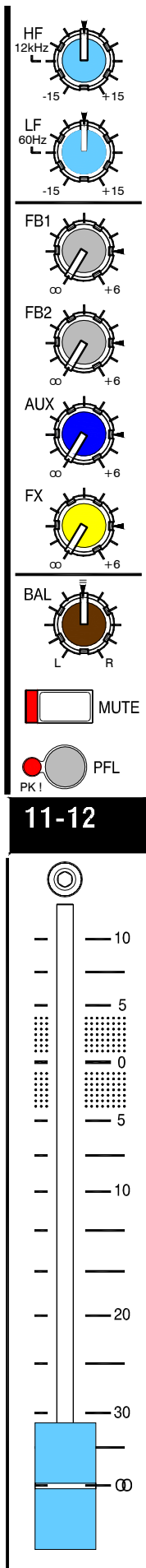

EQUALISER The stereo equaliser allows independent adjustment of the low and high frequency bands.

HF The high frequency band has a shelving response that cuts or boosts the higher (treble) frequencies by up to 15dB. It has most effect from 12kHz and higher.

LF The low frequency band has a shelving response that cuts or boosts the lower (bass) frequencies by up to 15dB. It has most effect from 60Hz and lower.

i **The EQUALISER** is based on the classic Baxendall design similar to that found in audiophile hifi systems. Its shelving response has an increasing effect as it approaches the low and high frequency extremes.

😊 Using the equaliser It is best to keep the adjustments made using the equaliser as small as possible. Avoid the temptation to excessively boost the low and high ends to compensate for poor speaker frequency response. This simply overworks the amplifiers with little audible improvement from the speakers. Using cut rather than boost is often more effective in improving the clarity of the signal. For example, use HF cut to quieten a hissy keyboard, some LF and HF cut to shape a reverb return, and LF to cut back low frequency hum or resonance. On the other hand, a small amount of HF boost can brighten up a dull recording, or add some 'air' to keyboard string sounds.

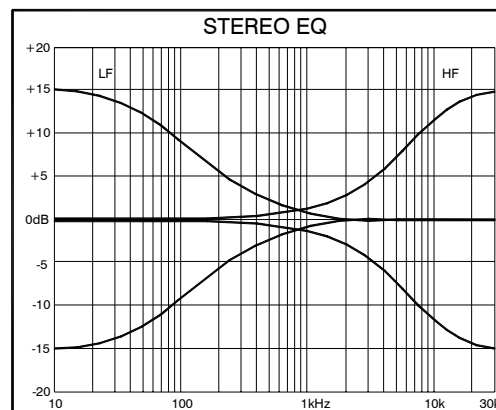

AUX SENDS The stereo channel aux sends function in the same way as described previously for the mono channels. Note that the L and R signals are summed together to produce a mono send for each of the four auxes.

BAL Adjusts the level balance between the L and R signals. At its extreme ends one signal is fully off, the other fully on. The control has a 3dB attenuation at its centre position to ensure equal total power as the balance is adjusted.

MUTE, PFL, PK! And FADER Function in the same way as described previously for the mono channel. Note that the stereo signal is summed to produce a mono PFL feed. The PK! Indicator senses the higher of the L and R signal levels. The fader controls the L and R signals together.

⚠ To avoid loud clicks or unexpected noises always mute the channel before plugging or unplugging the inputs. Use PFL to set the channel gain before raising the channel fader and sends.

The EFFECTS Channel

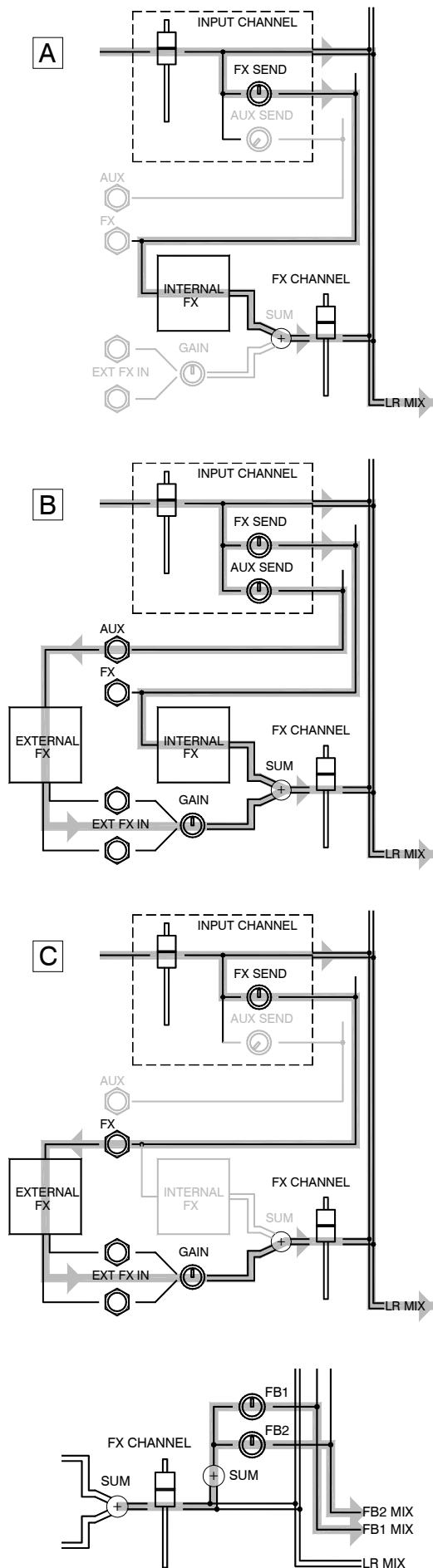

Overview The **PA Series** features a built-in digital stereo effects unit. Effects such as artificial reverberation, delay, echo and chorus can be selected from the 16 presets. You can independently control how much effect is added to each signal in the mix using the channel FX sends. The overall level of the effects in the LR and foldback mixes is adjusted using the effects channel described here. An external input facility is included so that the return from an additional independently controlled effects unit can be mixed with the internal effects. Alternatively the internal unit can be switched off and the channel FX sends used to feed the external unit. The channel can be muted using a footswitch for performer controlled effects bypass, for example between songs. The effects may also be turned on or off (bypass), and the preset changed using MIDI.

The Signal Path The signal flow diagrams shown here illustrate how the effects system works.

A Internal effects only The channel signal is routed through the fader direct to the main LR mix. A portion of the signal is also routed to the internal effects processor by turning up the channel FX send control. As this is sourced after the fader, the balance between the direct and effects signal is kept the same regardless of fader position. The processed signal is routed through the FX channel fader back into the LR mix where it adds with the direct signal.

B Internal and external effects Here the internal effects work as described above. In addition, an external effects processor is patched in as shown. The signals sent to this unit are independently adjusted using the channel AUX send controls which route it to the AUX output. The processor stereo output is plugged into the EXT FX IN sockets. GAIN matches it to the operating level of the channel. The external signal sums with the internal effects and is routed through the FX fader to the LR mix. This lets you work with two independently controlled effects units returned through a common effects master channel.

C External effects only If you prefer, you can switch off the internal effects processor and use its FX sends and the FX channel with your favourite external unit. This way, no controls are wasted when the internal unit is not used.

i Wet and dry signals The signal sent from the channel to the LR mix is referred to as 'dry'. This is the original signal with no effect added. The portion of signal routed through the effects processor is referred to as 'wet' because it is effect only. Consider room reverberation: The listener hears the voice of the singer (dry) and also the acoustic reflections (wet) as the voice reverberates around the room. The bigger the room the more reverb is heard. The **PA Series** simulates reverb in the same way. The reverb is created electronically using the digital processor (wet) and then added to the direct (dry) signal. The channel FX sends determine how much reverb is added to each signal in the mix.

Adding effects to the foldback The above describes how effects are added to the LR mix which feeds the house speakers. You can also add the effects to the foldback mixes by turning up the FX channel FB1 and FB2 controls. The signal is sourced post-fade so that the fader becomes the master level control for the effects in the LR and foldback mixes.

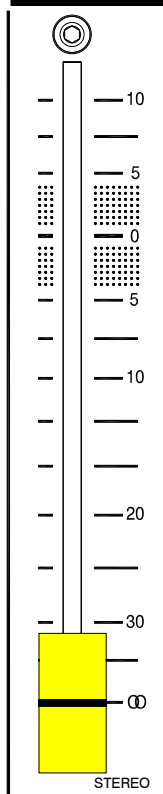
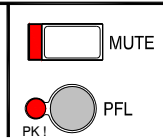
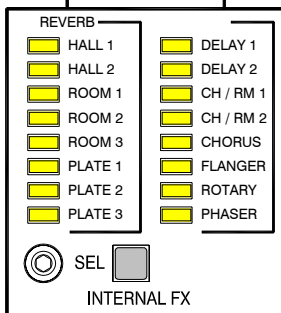
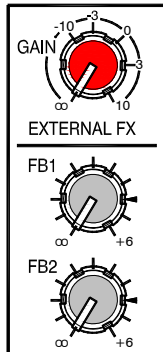
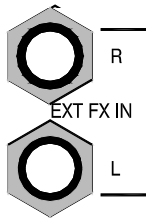

EXT FX INPUT TRS jack inputs for connecting the line level stereo output from an external effects processor. The inputs are unbalanced but can also accept balanced sources without modification. The ring connection grounds the -ve (cold) signal to unbalance a connected balanced source.

GAIN Adjusts the sensitivity of the input preamp to match the connected source to the 0dBu operating level of the FX channel. The control has a range from fully off to +10dB boost so that sources from -10dBu and higher can be connected.

 **Setting the gain** Use the channel PFL function to view the signal level on the console meters. Adjust the gain control for average signal level around meter '0'.

FB1 and FB2 Use this control to adjust the overall level of the effects in the FB1 and FB2 foldback mixes. The range is from fully off to +6dB boost. The unity 0dB position is marked. The signal is sourced after the fader. This means that moving the FX fader also adjusts the level of effects in the foldback mix.

 **Effects in the monitors** Only add effects to the foldback monitor mixes if they are really needed. Add as little as possible. It is best to avoid effects such as reverb in the monitors as they can increase the risk of feedback and can reduce clarity. Start with the FB1 and FB2 controls fully off.

SEL Press this button to scroll through the 16 available effects presets. One of the yellow LEDs lights to indicate which effect is active. The scroll has 17 conditions, one of 16 LEDs turned on, then all LEDs turned off. All off means that the internal effects processor is disabled. Use this state if you want to work with external effects only.

MUTE Press this switch to turn the FX channel signal off. This affects both the internal and external effects signals. The large red LED lights to warn that the channel is muted. Note that the LED also lights when the channel has been muted by the footswitch. Mute also turns off the LR and foldback effect signals. It does not affect PFL. You can still use PFL to check the effects signal while the channel is muted.

PFL Press this switch to listen to the effects signal in the headphones and display its level on the main meters. PFL is sourced pre-fader, pre-mute and sums the L and R stereo signal into mono.

 **Using PFL** Use PFL to check the sound quality and channel gain setting. You should hear the signal in your headphones and see its level displayed on the console meters. Adjust the gain control so that the meters read an average '0' when the external processor produces its optimum output. The signal may sound a little strange in your headphones because you are listening to the effects (wet) part only. This is the sound that adds to the direct mix to produce the effect.

PK! The PFL switch LED also provides the channel signal peak indication. The indicator lights brightly when the pre-fade signal reaches +16dBu. This means that it lights 5dB before clipping to give you the chance to reduce the signal before you hear any distortion. If the PK! Indicator flashes turn back the channel gain control until it stops.

FADER A 100mm smooth travel fader adjusts the overall effects level feeding the LR mix and foldback sends. It provides up to +10dB boost above its unity gain '0' position, and shuts off fully when pulled back to its bottom position.

The 16 Presets The effects presets have been configured to provide a variety of instantly accessible effects types suitable for live sound mixing. Listen to each preset so that you become familiar with how they sound. You may soon identify a few favourites.

Power Up Memory The effects processor remembers the last preset selected on power down. It also remembers the last MIDI bypass setting.

Disabling the Internal Effects To disable the internal processor press the SEL button to scroll through until all the preset LEDs are turned off. This is the press after the last preset (PHASER) is reached. To enable the effects, press SEL again to scroll to the preset you want. You can still use an external effects unit while the internal processor is disabled, or use the effects return as another stereo input channel.

FOOTSWITCH You can use a footswitch to operate the FX channel mute function. This affects both the internal and external effects signals. Use a switch that shorts the jack tip to sleeve when pressed. Use a momentary switch for press-and-hold operation, or latching for press-to-mute / press-to-unmute operation. Note that the footswitch will have no effect if the MUTE switch is already pressed.

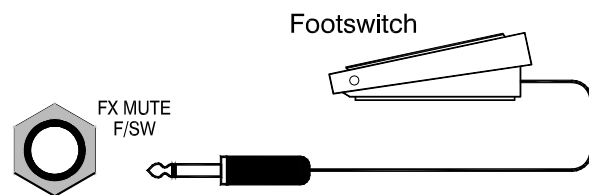

 **Using the effects** Start with the channel FX sends turned fully off and the FX channel fader set to its normal '0' position. Make sure that FX MUTE is not selected, or the MIDI bypass turned on. Choose one of the 16 effects presets. Raise a channel fader to route a sound to the LR mix. Now turn up the channel FX send control. You should start to hear the effect adding to the sound.

Stereo effects such as reverb add ambience to the mix. Experiment with the different presets to hear which work best for you. Avoid the temptation to add reverb to all sounds in the mix. For a natural sound try to add only small amounts. For special effects higher settings can be used.

To reduce feedback and ensure clarity on stage avoid adding reverb to the foldback monitors where possible. It is best to use the effect on vocals and instruments such as snare drum, woodwind, brass, acoustic guitars and keyboards. We recommend that you do not use reverb on bass guitar, kick drum or sources susceptible to feedback such as lectern, stage or radio mics. HALL is a good general purpose reverb. Short, bright reverbs such as ROOM or PLATE can add life to vocals. DELAY effects can add slapback or echo and are popular with singers, particularly those covering songs from the early years.

Use the FX fader, MUTE switch, footswitch, or MIDI bypass function to reduce or turn off the effects between songs. Use a MIDI device such as sequencer or keyboard to remotely change the preset type.

PRESET TYPES The following table lists the 16 effects available and their typical application. Try these with different instruments and sounds to create new and interesting effects.

HALL1	A bright hall reverb for drums, guitars and vocals.
HALL2	A warm hall reverb for acoustic guitars, pianos and vocals.
ROOM1	Hardwood studio for acoustic instruments
ROOM2	Ambience for acoustic mixes and synthesiser sounds
ROOM3	Warm room for guitars and rhythm instruments
PLATE1	Classic plate reverb for lead vocals and instruments
PLATE2	Bright plate reverb for vocals and drums
PLATE3	Short vintage plate reverb for snare drum and guitars
DELAY1	125ms slapback delay for vocals and guitars
DELAY2	190ms delay for percussive arpeggios
CHORUS/ROOM1	Chorus with reverb to thicken up guitars and keyboards
CHORUS/ROOM2	Chorus effect with reverb for lead instruments
CHORUS	Stereo chorus for guitars and keyboards
FLANGE	Classic stereo flange effect
ROTARY SPK	Rotary speaker emulation for organs and guitars
PHASER	Stereo phasing effect

MIDI IN



MIDI A standard 5-pin MIDI IN socket is provided. This provides remote control of the internal effects via MIDI. You can use a MIDI sequencer, keyboard or other controlling device to remotely change the preset type, or to bypass (turn off) the effect. Program change messages are used.

MIDI Channel Number The console uses MIDI channel number 1 (00H). This is fixed and cannot be changed. Make sure the equipment you are connecting to is set to use channel 1.

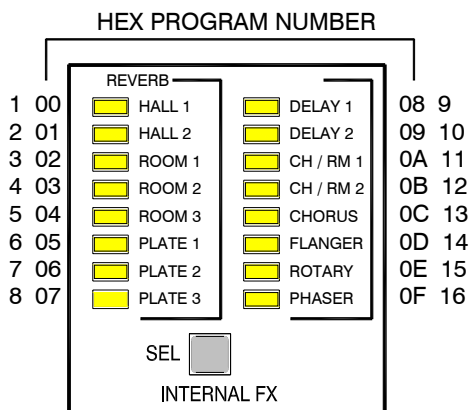

Using MIDI to bypass the effects

MIDI Program Change message CnH xxH
 Where xx = 65H (mute on) 64H (mute off)

Using MIDI to change the effects preset

MIDI Program Change message CnH xxH
 Where n = MIDI channel number
 xx = 00H to 0FH (preset 1 to 16)

The MASTER SECTION Controls

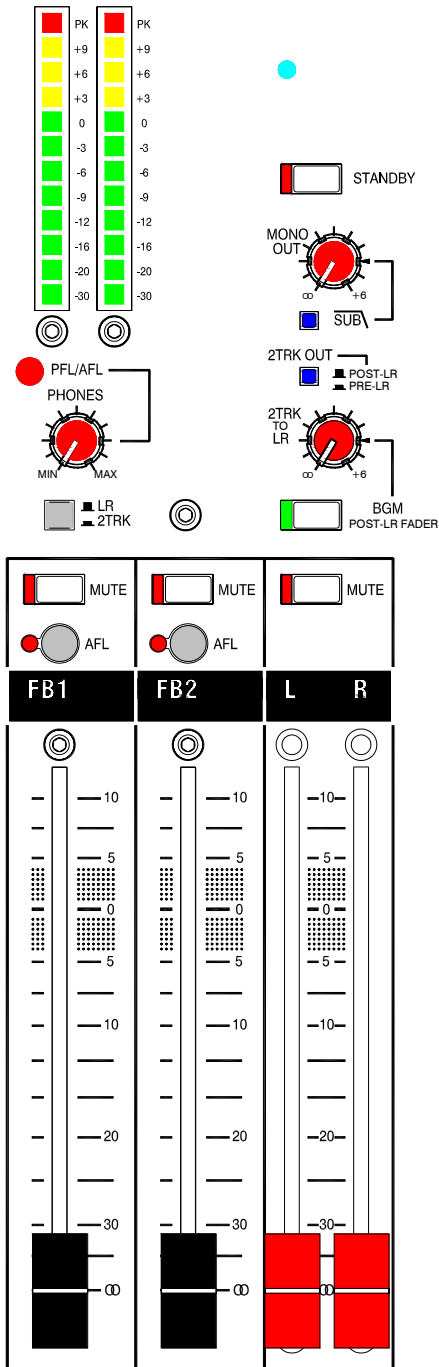

Master Control For accurate control, the main house and two foldback mixes are controlled using full length faders and include mute and headphone monitoring functions. These faders act as volume controls for the mix.

FB1, FB2, LR FADERS 100mm smooth travel faders adjust the overall level of the mixes. Up to +10dB boost is provided above the unity gain '0' position, full shut off when down. Normal operating position with the gain structure correctly set is typically between '-10' and '0'.

FB1, FB2, LR MUTE Press this switch to turn the mix off. The large red LED lights to warn that the output is muted. MUTE does not affect the foldback mix AFL function.

FB1, FB2 AFL Press this switch to listen to the foldback mix signal in the headphones and display its level on the main meters. AFL is sourced after the fader but before the mute switch. This lets you check the mix while the output is muted.

AFL stands for After Fade Listen. It sends the signal taken after the fader but before the mute switch to the engineers personal headphones monitor and console meters. AFL is more useful than PFL for output monitoring as it shows you exactly how much signal will be sent from the console to the connected equipment.

Gain structure is all about getting the signal levels between the stages in an audio system correctly matched. If a signal is too low then you are likely to hear the residual hiss and noise that is present in all electronic circuits. If it is too high then there is a danger that it will try to exceed the maximum output and therefore be clipped causing audible distortion. Get it right and you will achieve a noise floor too low to be heard and enough headroom to allow for the typical live sound peaks. You need to consider the matching between the microphones and the channels (gain), inserted equipment (operating level and trims), channels to the mix (faders), and outputs into the amplifiers (level trims). The diagram here illustrates the principles of signal dynamics.

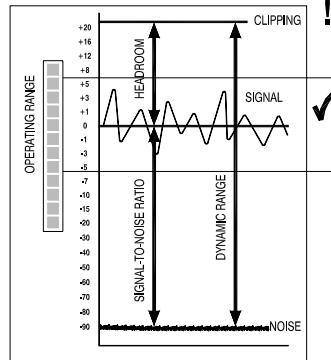

Checking the gain structure Start with the master faders and amplifier level controls fully off. Having first used PFL to set gain, route a test signal into the mix by bringing up the channel fader to '0' and raising the FB1 and FB2 sends to their 3 o'clock unity gain positions. Next, raise the master faders to '0' and use AFL and the LR monitor to check each mix for signal reading around '0' or just below on the console meters. Only then should you start to turn up the amplifiers until maximum expected volume is reached. This means that the console is operating at its optimum level for the desired speaker volume. You should find yourself mixing with the master faders between '-10' and '0'. If you work with very low fader settings you may start to hear some background hiss associated with the console output stage. Correct this by turning back the amplifier levels and raising the master faders.

MONO OUT LEVEL This is the master control for the console mono output. The LR mix is summed after the LR faders to produce the mono signal. Use the control to adjust the balance between the LR and MONO feeds. Once set, use the LR fader as the house volume control affecting the LR and MONO outputs. The control ranges from fully off to +6dB boost above its unity gain position.

SUB FILTER Press to switch in the 100Hz low pass filter. This is a built-in crossover filter to condition the mono output for driving a sub bass amplifier/speaker. Frequencies above 100Hz are rolled off at 12dB per octave. The switch is recessed to prevent accidental operation once set. Use a pen or sharp object to change its position.

i **Sub bass speakers** are large coned drivers, typically 15" or 18", built into reasonably large cabinets designed to reproduce the very low frequencies. They are referred to as 'subs'. They are not used by themselves. Smaller speakers often referred to as the 'tops' are added to reproduce the mid and high frequencies. Without a filter the sub can reproduce frequencies as high as 500Hz or more. This can cause a sub/top combination to sound 'boxy' or 'muddy'. For this reason a filter is added to cut frequencies above the required frequency range, usually around 100Hz. This filter may be built into the sub cabinet, its amplifier or a separate crossover unit. The **PA Series** adds the switchable 100Hz filter for situations where no filter is provided. Check your sub speaker instructions to see if it is needed.

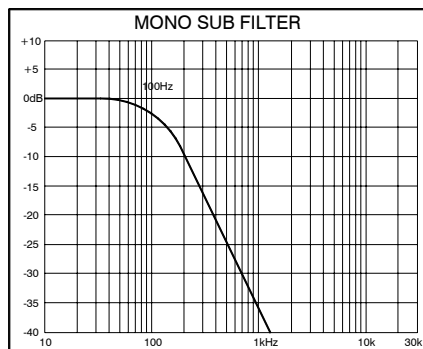

Background Music (BGM) The console provides a facility for playing an independently controlled stereo music source such as CD through the house speakers while the main LR faders are off. This is ideal during walk in or while taking a break during intermission.

BGM Routes the 2-track input to the LR outputs after the master fader but before the mute switch. This means that the signal is not affected by the fader but is turned off when MUTE is pressed. A large green LED lights when BGM is selected.

2TRK TO LR Controls the level of the 2 track signal to the LR output from fully off to +6dB boost above '0'. It has no effect if the BGM switch is off.

▲ **To avoid feedback do not use BGM if you are using the 2-track input to monitor a recording being made from the LR mix.**

2TRK OUT Selects the 2-track output feed to be pre or post LR faders. It affects both the analogue and digital (SPDIF) outputs. In its normal up position the source follows the fader movements. When the switch is pressed, the LR faders can be used as the house PA volume control without affecting the recording. The switch is recessed to prevent accidental operation once set. Use a pen or sharp object to select its position.

STANDBY Pressing this switch puts the console amplifiers into protect mode by isolating the speakers. You should hear the relays click as the amplifier outputs are disconnected. The large red LED and two AB amplifier PROTECT LEDs light while standby is selected. Use STANDBY to protect the speakers while plugging equipment or leaving the console unattended.

Console Monitor The **PA Series** monitor system lets you listen to the various console signals using headphones, and check levels on two large LED bar meters. Using the monitor does not affect the main outputs.

HEADPHONES LEVEL Controls the volume of the selected monitor source in the headphones. It does not affect the level displayed on the meters.

▲ **WARNING: To prevent damage to your hearing start with the headphones level set to minimum. Avoid continued high listening levels in the headphones or any other earpiece.**

LR/2TRK Selects the normal headphones and meter monitor source. In its up position the post-fade LR signal is selected. When pressed, the 2-track input is monitored. Pressing any PFL or AFL button automatically overrides this selection.

PFL/AFL LED A large red LED indicator lights to warn you when a PFL or AFL has been selected.

METERS A pair of 12 segment LED bar meters displays the level of the selected monitor source. The LR mix and 2-track input are displayed in stereo, and PFL/AFL signals in mono on both bars.

i **PFL** stands for Pre-Fade Listen. It is used on the inputs so that you can check the signal while the channel is muted or its fader down.

i **AFL** stands for After Fade Listen. It is used on the outputs so that you can check the signal exactly as it is at the console outputs.

☺ **Using PFL and AFL** Use PFL to check sound quality and the channel gain setting when plugging in different sources or when you suspect a change or problem with a particular signal. Use AFL when you need to check one of the foldback mixes. You should hear the signal in your headphones and see its level displayed on the console meters. Adjust the gain and mix controls so that the meters read an average '0' with loudest peaks no more than '+6'.

The AMPLIFIERS

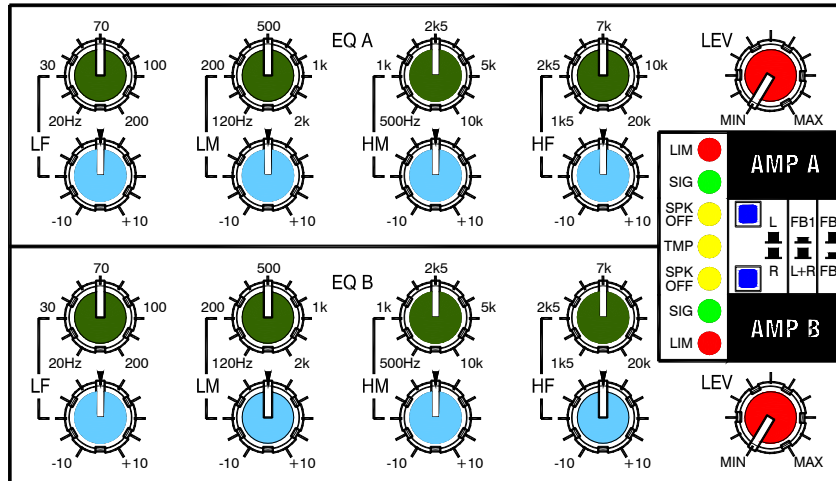

Overview The two built-in power amplifiers are called Amp A and Amp B. You decide how you want to use them. Different combinations of the LR, FB1 and FB2 mixes can be selected according to your preferred system setup. Each channel includes a 4-band semi-parametric equaliser for precise speaker/room frequency shaping. The level controls let you match the console signals to the speaker volume you require. A row of LED indicators display important information about the amplifier status.

The philosophy Our objective was to produce a powerful, good sounding amplifier in a compact package for the high end audio application. The result is a third generation design benefiting from many refinements and lessons learned, and adding a few unique touches of our own. There are none of the common frequency boosting tricks to try to sweeten the sound from low quality speakers. Instead we chose to provide a perfectly flat, accurate response with genuine performance figures.

The design uses a bipolar assisted MOSFET Class AB configuration producing a total of 1kW continuous music power into 4 or 8 ohms. A heavy duty linear power supply ensures rock solid bass and full range clarity. The amplifier is fully protected. Short circuit protection is provided with precision sharp knee current limit. A built-in program dependent clip limiter monitors the output easing psu stress and preventing harmful overload. Temperature is controlled using a 3 speed twin fan thermal management system with cut out on overload. The fans run slow on power up, medium speed when 35 degrees C is reached, fast speed at 50 degrees, and thermal cut triggers at 85 degrees. The speakers are protected using relays which activate if a fault is sensed and have a two second switch-on delay and instant power off.

Constant power Most amplifiers produce their maximum output into 4 ohms with considerably less into 8 ohms. The unique **PA Series CP** system achieves its full rated 500W+500W into either impedance. This is done using a rear panel slide switch which sets the power supply for maximum current (4 ohms) or maximum voltage (8 ohms).

LEVEL Sets the input level to each channel of the amplifier. Turn the control fully off when plugging up the equipment. For normal operation turn it up to the position where it produces loudest volume required when the console meters are reading around '0'.

SIGNAL METERS Each channel provides two meter indicators. The green SIG indicator turns on when audio signal presence is detected. The red LIM indicator turns on when the built-in limiter starts to work and the amplifier is producing close to its maximum output. If LIM lights then back off the amplifier LEV control until it turns off.

SPK OFF The yellow SPK OFF indicator on each amplifier channel lights when the speaker relay is turned off. This happens during the power up delay, when the amplifier has been put into standby mode, or when a fault condition is detected.

TMP The TMP indicator lights when the amplifier operating temperature reaches 50 degrees C and the cooling fans are running at fast speed. It is quite normal for this to light when the amplifier is working hard.

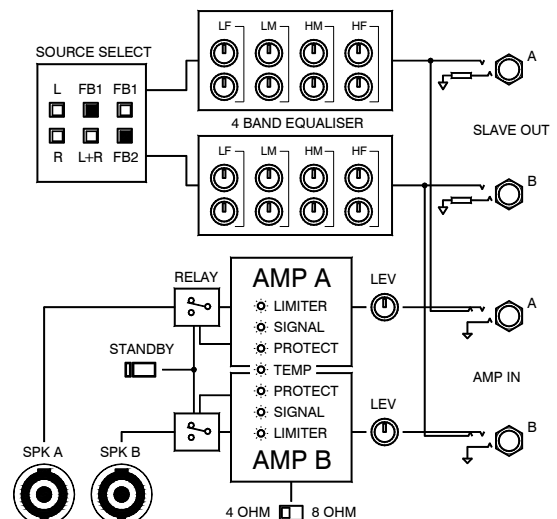

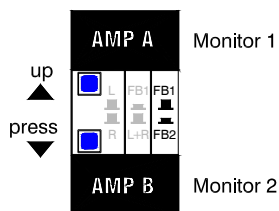
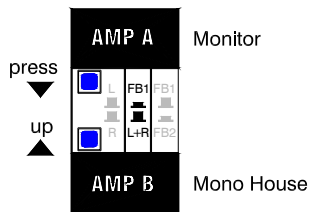
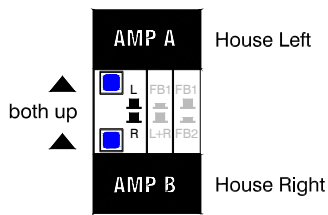

SOURCE SELECT Decide how you want to use the amplifiers. Set the two switches according to the A and B sources required. The switches are recessed to prevent accidental operation once set. Use a pen or sharp object to change their settings.

Front-of-House refers to the audience listening area. It is commonly called FOH or simply 'house'. The house speakers provide the PA for the audience.

Foldback monitors Monitors are wedge shaped and 'hotspot' speakers, headphones and earpieces used by the performers to hear themselves and others on stage. Foldback is the term used to describe the process of returning some signal from the console back to the performers.

Different amplifier configurations The PA Series amplifiers can be used in many different ways. Sound system requirements vary for many reasons. You may want to run a stereo house system with separate left and right speakers and no monitors, or a mono system with a foldback monitor. You may be using external amplifiers for a bigger house system and therefore use your PA Series amps for a pair of stage monitors. You may be using powered speakers throughout and so apply the amps to a different task altogether.

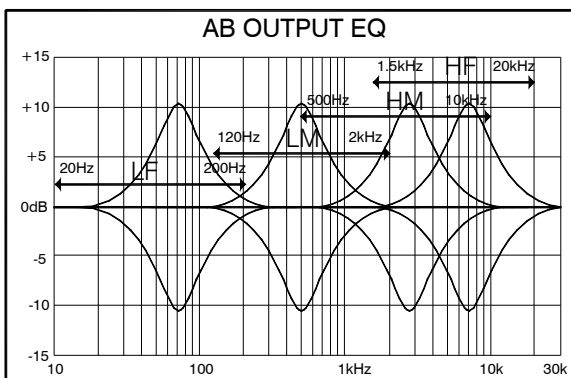

The Output Equalisers Each AB amplifier channel features a 4-band semi-parametric EQ. This divides the audio range into four overlapping frequency bands. Each band has a bell shaped peak/dip response with adjustable gain and tuneable frequency.

LF, LM, HM, HF The lower control cuts or boosts the frequencies around the centre point by up to 10dB. The flat response centre position is detented to help you find it quickly.

FREQUENCY The upper control adjusts the centre point frequency of the band. The width of the bell, or Q, is 1.8 measured at +10dB.

Why the parametric output EQ? You are probably familiar with the 7 or 9-band graphic EQ used on traditional powered mixers. These have a similar bell shaped response but set at fixed frequency points. The PA Series parametric design provides much more accurate control because you can tune each band to the exact frequency required. It also has a tighter width per band so reducing the unwanted effect on nearby frequencies. Used carefully you can deal with poor room or speaker response and deal with feedback while maintaining the fidelity of the original sound. In modern sound engineering the parametric EQ is the professional engineer's choice for accurate frequency shaping.

Using the output equalisers The best advice is to use as little EQ adjustment as possible, and to cut rather than boost. Before or during sound check, start with all bands set flat with their gain and frequency controls at mid position. Avoid the typical 'smiley face' EQ that overloads the amplifiers in an attempt to get more range from inadequate speakers. A small amount of boost at 70Hz and 10kHz can achieve the desired results. Using a good test source such as CD or pink noise, listen for resonant or 'boomy' frequencies in the room, and frequencies that start to feed back or 'ring' when microphone gain is gradually increased. Adjust the controls to tune in to the offending frequencies and apply only small amounts of cut.



Experiment with the Allen & Heath Windows™ EQ Visualiser software. This lets you see how the adjustments you make with the EQ controls can affect the signal frequency response.

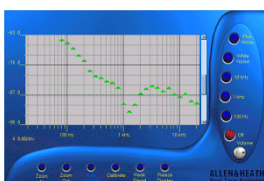

Download the Allen & Heath RTA (real time analyser) software from our web site. This is an invaluable tool to help you identify and use the EQ to correct problem room and ringing frequencies.

The MASTER Connectors

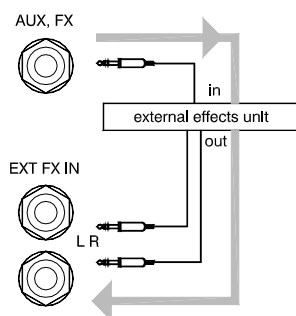
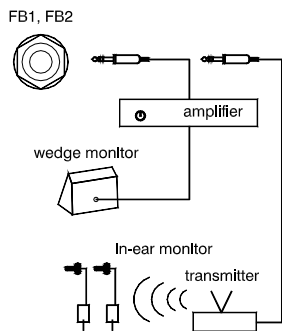
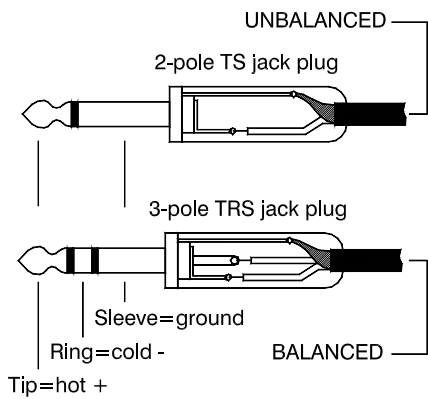
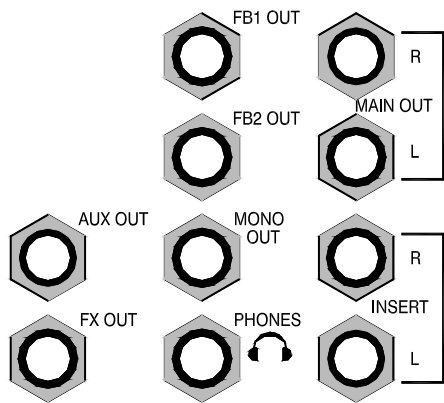

TRS Line Outputs 1/4" jack line level outputs which produce 0dBu when the console meters read '0'. With a maximum output level of +21dBu there is plenty of headroom available. They are impedance balanced and can be used with balanced or unbalanced equipment.

TRS jack refers to the popular 3-pole stereo 1/4" phone jack. It is so called because it has three contacts: tip, ring and sleeve. It is used with balanced audio signals (tip hot, ring cold), stereo signals (tip left, ring right), or single jack inserts (tip send, ring return). The 2-pole mono TS jack is used with unbalanced signals.

Line level refers to audio signals in the region of 1 volt. For comparison, Mic level refers to very low level signals in the order of millivolts, and Speaker level refers to amplifier output levels in the order of tens of volts. Several line level standards exist. These refer to the 'nominal' operating level, the point at which the meters read '0'. Professional audio equipment generally works at 0dBu (0.775V) or +4dBu (1.23V), while semi-professional or consumer equipment often works at the lower -10dBV (0.31V). The **PA Series** has a very wide dynamic range making its 0dBu referenced outputs well suited to working with these standards.

Using line level signals Use these outputs to feed line level equipment such as amplifier, signal processor, recorder and IEM transmitter inputs. Do not connect them directly to loudspeakers, or to phantom powered inputs. Adjust the sensitivity of the connected equipment to match the normal 0dBu operating level of the console.

Impedance balanced outputs, like differential electronic balanced drivers, use a 3 wire connection and provide the benefit of interference rejection when plugged into balanced equipment inputs. The signal is carried on the tip and is referenced to ground on the sleeve. Unlike the electronically balanced connection, the ring does not carry signal. However, it is held at the same impedance as the tip signal wire. This means that interference is injected equally into both the tip and ring wires and cancels out when plugged into a balanced input leaving the audio signal unaffected.

Using balanced or unbalanced connections Use balanced 2-core plus screen connections when you connect the outputs to balanced equipment with cables longer than 10 meters. The **PA Series** outputs work at line voltage and very low impedance making unbalanced single core plus screen connections suitable for short cable runs as these are seldom prone to interference. To reduce interference pickup avoid running the cables near to or alongside mains power, lighting or computer equipment and cables.

FB1, FB2 OUT Use these pre-fade aux sends to drive two independent foldback monitor amplifiers, or transmitters if you are using in-ear monitors (IEM).

AUX Use this post-fade aux send to drive an external effects unit, or for a special feed such as mono recording, audio for video feed or additional speaker zone.

FX This output follows the channel post-fade sends to the internal effects unit. Use it when you are not using the internal effects unit, or to feed an external effects unit at the same time for layered effects.

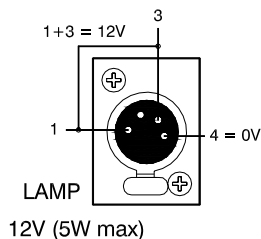
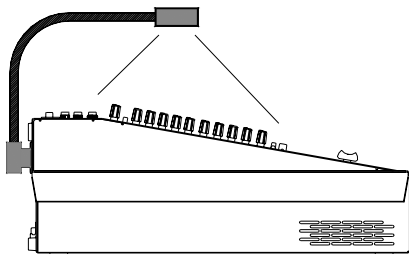
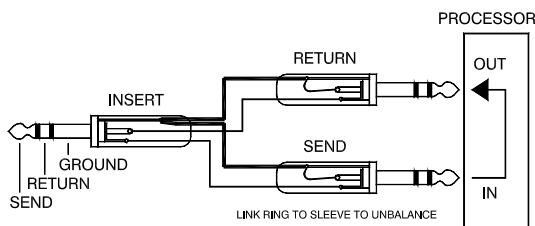
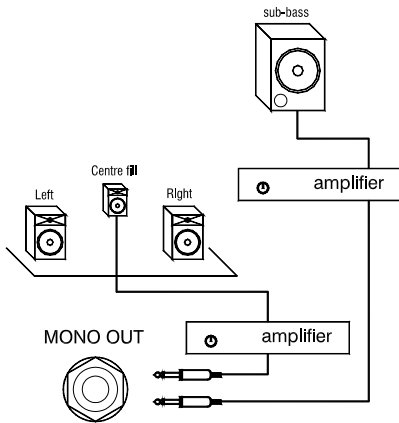
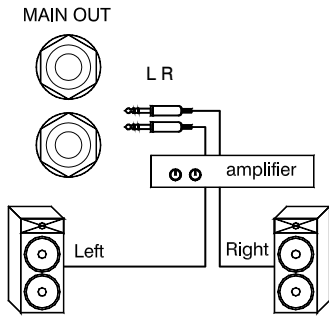

LR MAIN OUT Use these line outputs to drive the main house amplifiers if you are using the console AB amplifiers for the foldback monitors. If the AB amps are powering the house speakers you could also use the LR outputs to feed booster amplifiers for additional speakers in the system.

MONO OUT The main L and R outputs are summed together to produce a mono line level output. Typical applications include feeding an external amplifier for a mono PA, a fill or zone speaker, or driving a sub bass amplifier/speaker system (sub filter switched in). Its level is affected by the LR fader which is used as the main PA level control.

😊 **Working with powered speakers** A powered speaker is a loudspeaker with a power amplifier built into its cabinet. These can be convenient to use with small portable systems as they save space. Simply feed the console TRS outputs to the powered speaker line inputs. You could, for example, use the console AB amplifiers to drive conventional house PA speakers, the FB1 and FB2 outputs to drive a couple of small powered foldback speakers, and MONO to drive a powered sub bass. To avoid problems such as ground loops make sure the mains power supply feeding the speakers is on the same circuit as that feeding the console.

LR INSERTS One TRS jack socket for each side of the main LR mix lets you patch in external processing equipment such as a stereo limiter, equaliser or delay unit. Plugging in interrupts the signal path after the mix stage and before the LR fader. With nothing plugged in, the signal is routed through the switching contact within the socket. The connection is unbalanced with both the insert send and return signals presented on the same jack. Connect the equipment input from the send (TRS jack tip), and its output to the return (jack ring). Wire both cable shields to the jack sleeve. The insert operates at 0dBu line level. Ensure that the external equipment is set to operate at similar level and unity gain. The diagram below shows a typical insert cable with plug links to unbalance the external equipment connections if they are balanced.

HEADPHONES The console monitoring system has a built-in stereo headphone amplifier which feeds a TRS output. It is wired conventionally with tip = left, ring = right. Plug in a standard pair of stereo headphones.

😊 **Choosing headphones** For best performance, clarity and reliability we recommend you use a high quality, closed ear design with impedance in the range 30 to 600 ohms. Lower impedance headphones such as the popular 100 ohms types usually produce a louder output. Avoid using the cheaper types that come with portable music players and consumer equipment.

⚠️ **To prevent damage to your hearing, avoid continued high listening levels in the headphones.**

Console LAMP A 4-pin XLR connector is provided on the rear panel for plugging in a gooseneck lamp to illuminate the control surface when working in a dark environment. Use a lamp with 12V bulb up to 5W power designed for this purpose.

⚠️ **To prevent damage to the console power unit do not attempt to modify the lamp connection or add more lamps.**

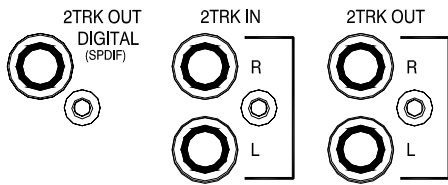

i SPDIF explained SPDIF stands for “Sony Philips Digital InterFace”. It is a standard developed by the consumer electronics industry for interfacing digital audio signals. It has the advantages that audio can be passed from one digital device to another without the need for analogue conversion, and that both the left and right signals are carried on a single cable. It has become popular with manufacturers of consumer and professional audio and computer products. There are two types for SPDIF connection, coax and optical. Coax uses the RCA connector and 75 ohm coaxial cable. Toslink is the optical version that uses fibre-optic cable. The coax version can work with cable lengths up to 15 metres.

2TRK INPUT A pair of RCA phono sockets accepts the input from a stereo playback devices such as a CD, MiniDisc, DAT or tape player. Use it to monitor a stereo recording in the console headphones, or to route a stereo source to the LR mix for background music. The input is unbalanced and has 0dBu line level sensitivity.

2TRK OUT The LR mix is also available at a pair of RCA phono sockets for connection to a 2-track recording device such as MiniDisc, DAT or tape recorder. The output is unbalanced and operates at 0dBu line level. It can be sourced pre or post the LR faders and is buffered from the LR connections to ensure that plugging in here does not affect the main output.

2TRK DIGITAL OUT A digital version of the 2-track output described above is available from this RCA phono socket. It is in SPDIF format and uses high grade ADC converters. Plug into the SPDIF coax input on equipment such as recorders, digital audio processors and computer sound cards. Bypassing the input ADC devices on such equipment can reduce audio quality degradation, especially if they use low grade devices.

😊 Connecting SPDIF Use 75 ohm coaxial cable. Pre-made SPDIF cables are readily available. You can also use standard 75 ohm coaxial video cable. Do not use standard RCA to RCA audio cables.

⚠ Do not plug SPDIF signals into analogue connections. While it is unlikely to cause physical damage it can result in unpleasant audible noise.

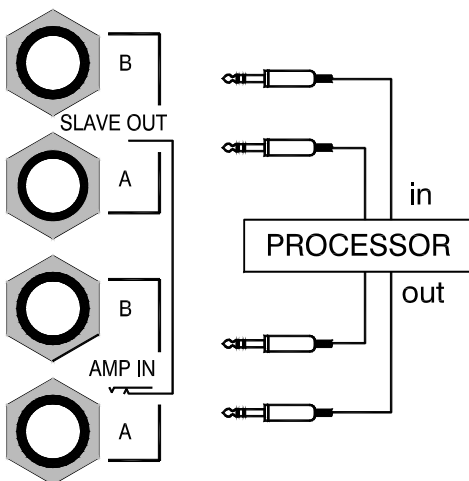

AB SLAVE OUT TRS line outputs for connecting to external line level equipment such as booster amplifiers and speaker processors. They are impedance balanced and can work with balanced or unbalanced inputs. Operating level is 0dBu. The output follows the panel AB source selection and EQ settings. It does not break the signal path to the AB amplifiers.

AB AMP INPUT TRS inputs to plug external equipment directly into the console A and B amplifiers. They are unbalanced and operate at 0dBu line level. Plugging into these sockets automatically breaks the internal signal path so that the amplifiers are fed by the external signals only. This lets you use the amplifiers for other purposes, or for patching in equipment such as speaker processors.

😊 Patching in speaker processors Several loudspeaker manufacturers provide processor units to equalise the response of their speakers. This is to compensate for the characteristics of the driver or box design. Typically, the unit is positioned just before the amplifier in the signal path. First read the instructions provided with the speakers. Plug the AB SLAVE OUT into the speaker processor. Plug its outputs back into the AB AMP IN sockets.

⚠ To avoid loud thumps or unexpected noises turn down the console A and B amplifier level controls while patching into the AMP IN sockets.

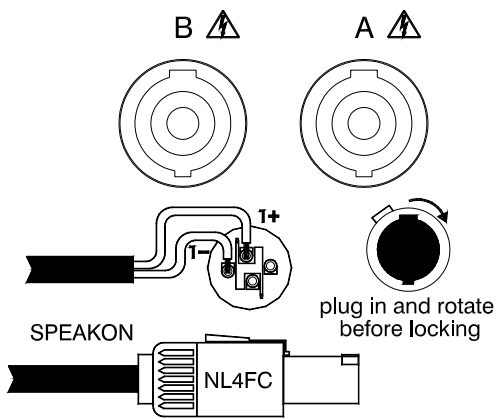

☺ **No amplifier output?** Check that the Speakon® plugs have been rotated and locked into position.

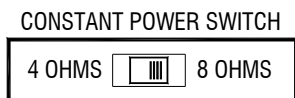
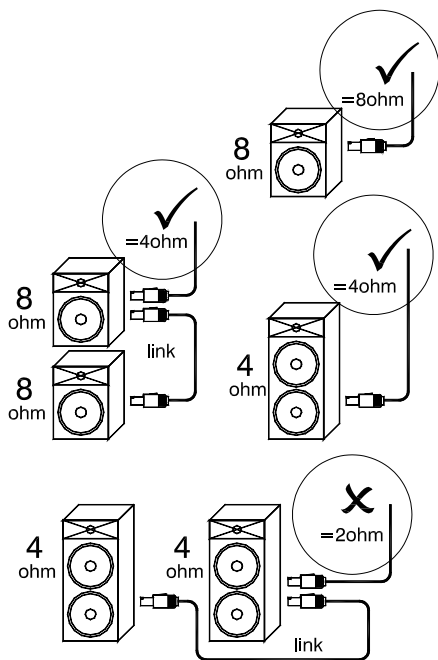

AB SPEAKER OUTPUTS The power amplifier outputs are available on Speakon® connectors. These are robust locking connectors designed to handle high power loudspeaker signals. The popular 4-pin NL4 version is used. Two pins carry the speaker signal. Wire the speaker positive (+) cable to pin 1+ and speaker negative (-) to pin 1- as shown. Use heavy duty 2-core speaker cable of at least 16swg (1.5mm²) rating. For long cable runs 14swg (2.5mm²) or heavier is recommended. Make sure that the connections are reliable and observe the correct polarity (speaker + to amp +, and speaker - to amp-). To connect the Speakon®, first align the locating tag and press the plug in. Next, rotate the plug clockwise until it locks in place. Audio signal will only be present once the plug has been locked in this way.

☺ **How to check speaker polarity** If the speaker + and - connections are crossed over they are referred to as wired 'out of phase', or more correctly, reversed polarity. This means that the speaker cone will be working backwards. The effect becomes obvious when you have more than one speaker in the system. You can carry out a simple listening test to check if two speakers are wired with the same polarity. Route the same mono signal to both speakers at a similar level. Pink noise is the ideal test source as it contains all audio frequencies at equal energy per octave. However, a music source will do. Stand half way between the speakers. Correctly wired, they will have a solid centre image with the sounds adding. Reversed wired, they produce a weak centre image with strange phasing effects due to frequency cancellation. If you hear this then check the wiring of the amps, cables and speaker connections.

Speaker Impedance Live sound speakers are typically 4 ohm or 8 ohm, although some are available at 16 ohms. Check the manufacturers specification. Usual application is one speaker per amplifier channel. However, there may be times when you want to wire them in series or parallel, for example when using one amplifier channel to feed two linked foldback wedges. Calculate the combined impedance to check that it is no less than the amplifiers rated 4 ohm minimum. Divide the impedances when connecting in parallel, add them when connecting in series.

⚠ **Do not connect a speaker impedance less than 4 ohms. Failure to observe this may result in damage to the amplifier.**

⚠ **Do not use bridged connection. Do not common or link the speaker pins in any way.**

CONSTANT POWER SWITCH Set the rear panel slide switch to match the impedance of the speakers used. Use the combined impedance value if you are connecting speakers in series or parallel. Choose the nearest match if the value is not exactly 4 or 8 ohms. Note that no damage will be done if the switch is left in the wrong position. However, you may not benefit from the full capability of the amplifier.

ⓘ **Constant power explained** The typical amplifier is optimised to produce full power into 4 ohms and therefore considerably less into 8 ohms. The **PA Series** features a unique facility that ensures you get full power output into either 4 or 8 ohm speakers. It does this by reconfiguring the power supply for optimum current (4 ohms), or voltage (8 ohms).

Specifications

Max output level	+21dBu into >2k load	Channel HPF	100Hz 12dB/octave
Nominal output level	0dBu (0.775 Volts rms)	Channel EQ	4-Band semi-parametric +/-15dB gain HF shelving 12kHz HM bell 350Hz to 7kHz LM bell 250Hz LF shelving 60Hz
Headroom	+21dB	Output EQ	4-Band semi-parametric +/-10dB HF bell 1k5 to 20kHz HM bell 500 to 10kHz LM bell 120 to 2kHz LF bell 20 to 200Hz
Freq response	+/-1dB 20Hz to 30kHz	Mono Sub LPF	100Hz 12dB/octave
Distortion	< 0.006% THD+N @1kHz +10dBu	Faders	100mm Alps
Crosstalk	<-90dB Channel to channel @1kHz <-95dB Mute shutoff <-95dB Fader shutoff	Digital Effects	Stereo output 16 presets
MIC EIN 22-22kHz	-128dB 150 ohm source	MIDI	Effects preset select Effects bypass Channel number = 1 (00H)
Residual noise	< -88dBu		
Mix noise	< -84dBu		
Meters	Peak reading 12 LED -30 to +16dB		
Channel Peak	5dB before clipping		

Amplifiers

Configuration	Class AB bipolar assisted MOSFET
Power output	500W + 500W rms music power into 4 ohms or 8 ohms
Constant power	Rear panel slide switch – Set for 4 or 8 ohms
Distortion	< 0.02% THD+N @1kHz
Limiter	Program dependent output sensing input clip limiter
Protection	short circuit, overload, DC, thermal cut out
Cooling	Twin variable speed fan, ducted heatsinks

Power Supply

Internal linear power unit using toroidal transformer.

MAINS IN socket	IEC 3 pin
Power lead	Country dependent with moulded mains plug supplied
AC mains	100 to 240V AC @ 50/60Hz internally wired
Consumption	1600W max (peak)
Mains fuse rating	100-240V AC T10A 250V 20mm (A&H part number: AL3455) Manufacturer: Schurter Part number: 0034.3127

Mechanical

Mounting	Portable with carry handle, freestanding desk or floor 19" rack ears provided with PA12-CP Rack ears mount in two positions - straight 10U, angled 11U
Panels	Controls 10 degrees, top connectors, rear mains and speaker connectors

	Width	Height	Depth	Weight
PA12-CP (desk)	525 mm (20.6")	178 mm (7.0")	539 mm (21.2")	21 kg (46 lbs)
PA12-CP (rack)	484 mm (19.0")	446 mm (17.6")	178 mm (7")	21 kg (46 lbs)
PA20-CP	733 mm (28.9")	178 mm (7.0")	539 mm (21.2")	24 kg (53 lbs)

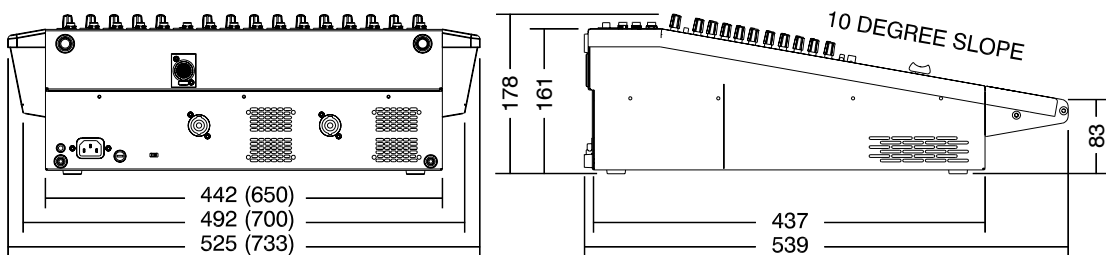

System Block Diagram

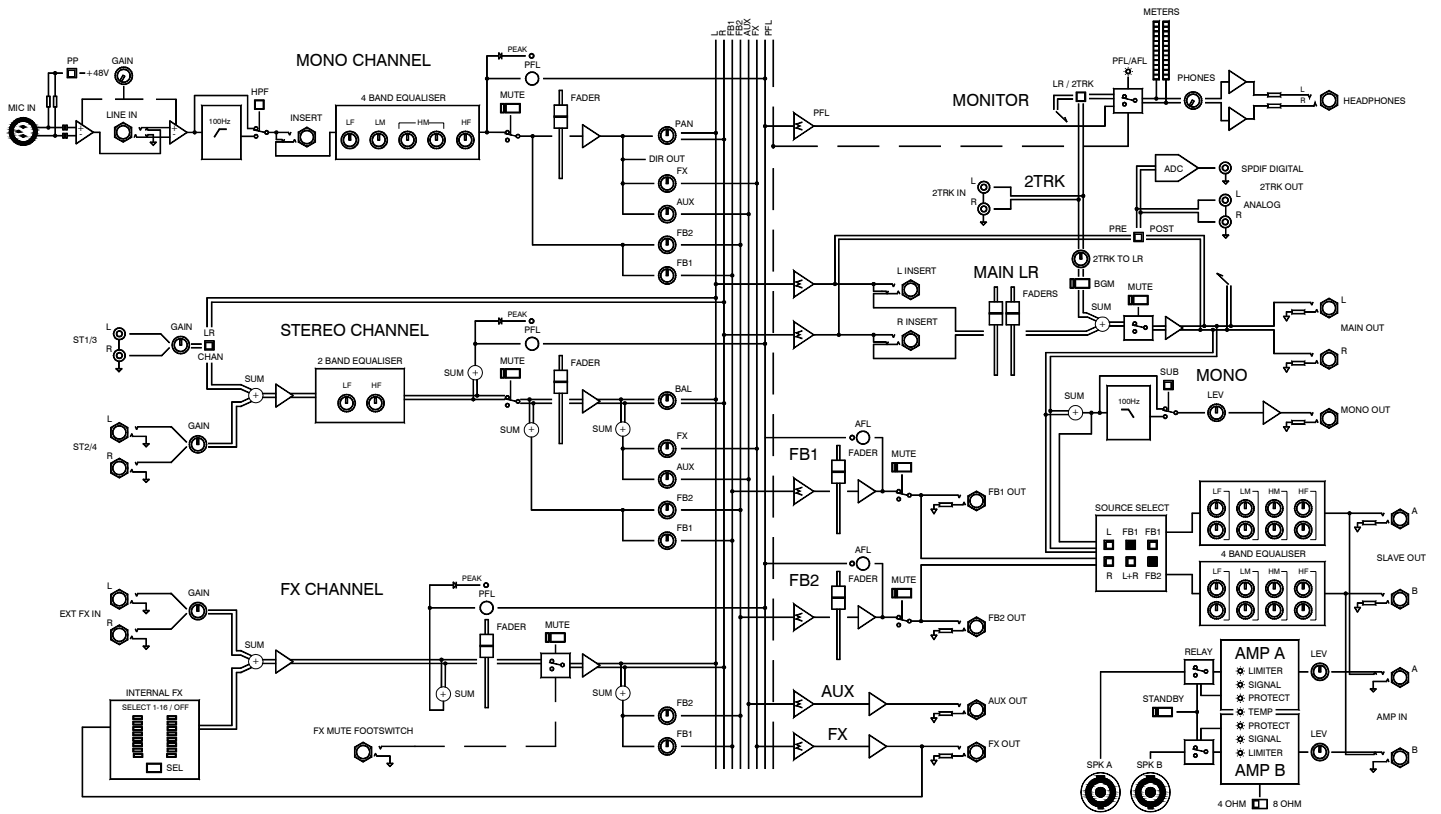

Connector Types

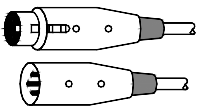

XLR connector : Pin 2 = hot (+) Pin 3 = cold (-) Pin 1 = GND
 TRS input and output connectors : Tip = hot (+) Ring = cold (-) Sleeve = GND

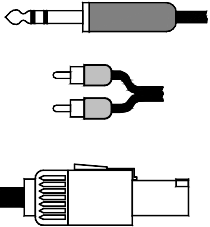

Input Connections

	Type	Impedance	Sensitivity
Mono MIC IN	Balanced XLR female	2k ohm	-63 to +5dBu
Mono LINE IN	Balanced TRS jack	>30k ohm	-25 to +10dBu
ST1,3 LINE IN L,R	Unbalanced RCA phono	>10k ohm	-10dBu max
ST2,4 LINE IN L,R	Unbalanced TRS jack	>10k ohm	-10dBu max
2-TRK IN L,R	Unbalanced RCA phono	>10k ohm	0dBu
EXT FX IN L,R	Unbalanced TRS jack	>10k ohm	0dBu
AMP IN	Unbalanced TRS jack	>10k ohm	0dBu

Output Connections

	Type	Impedance	Level
L, R, MONO,	Impedance balanced TRS jack	<75 ohm	0dBu
A, B SLAVE OUT	Impedance balanced TRS jack	<75 ohm	0dBu
FB1, FB2, AUX, FX OUT	Impedance balanced TRS jack	<75 ohm	0dBu
2TRK OUT	Unbalanced RCA phono	<75 ohm	0dBu
2TRK OUT (SPDIF)	RCA phono	75 ohm coax	digital
HEADPHONES	Tip = L Ring = R	30 to 600 ohm, 100 ohms recommended	
SPEAKER A, B	Speakon pin1+ = speaker positive, pin1- = speaker negative	Minimum 4 ohms. Do not bridge or common the pins	

Insert Connections

	Type	Level
Channel, LR	Unbalanced TRS tip = send, ring = return	0dBu

Fitting the PA12-CP Rack Ears

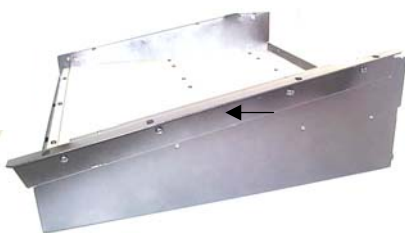
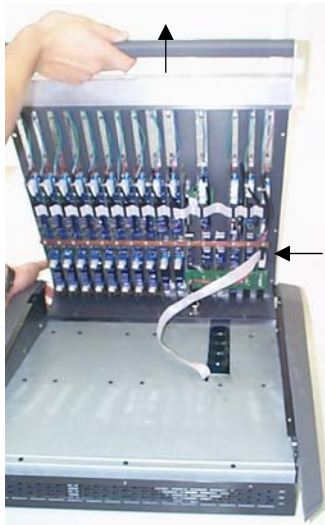
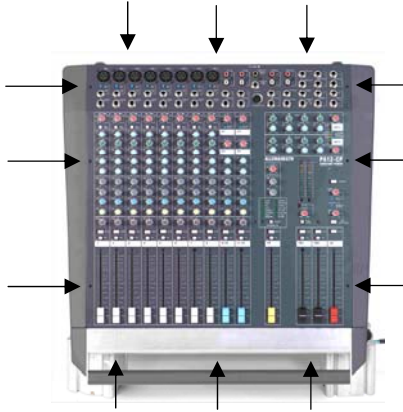

A pair of 19" rack ears is provided with the PA12-CP. The ears replace the front and side trims so that the console can be mounted in a rack, plinth or case. Note that the PA12-CP can fit into a standard 19" rack. The ears can fit in one of two positions depending on how you want to mount the console in the rack or other furniture.

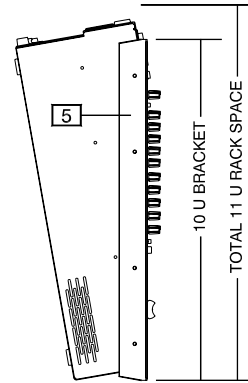
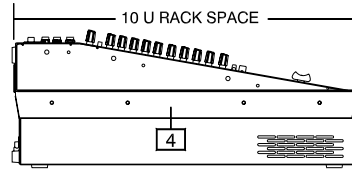

The top panel assembly needs to be removed from the base to gain access to the screws that hold the trims and ears in place. Ensure that you have a suitable work surface with adequate lighting and clear of any objects which may scratch or damage the console panels. Tools required include a number 2 Pozzi and T10, T15 and T20 Torx screwdrivers.

1 Remove the 6x M3 countersunk top panel screws. Also remove the 3x front and 3x rear M3 pan head fixing screws.

2 Carefully hinge the top panel assembly up from the base as shown. Support the rear so that it does not slip. Unplug the ribbon harness from the LR circuit card. You can now lift the panel away and place it inverted on the work surface.

3 Unscrew the 6x 6B pan head front trim fixing screws shown in the diagram. Take care to avoid damage to the faders. The front trim including the armrest and carry handle can be removed.

4 Locate the 4x internal M5 pan head screws fixing each side trim to the chassis. Remove both trims. Align the rack ears in the required position and fix these to the chassis using the 4x M4 countersunk screws provided per side. Ensure they are done up tight.

5 Check your work and ensure there are no loose parts or debris in the chassis. Align the top assembly with the chassis and plug in the ribbon harness. Make sure you align the plug correctly with the socket. Carefully lower the assembly into place. Refit the 6x top, 3x rear and 3x front fixing screws.

We recommend you keep the trims and their fixing screws in a safe place for re-use in the future.

⚠ Do not obstruct the front or rear ventilation slots or position the console where air flow required for ventilation is impeded. The console must not be operated in any carry or flight case that obstructs these slots. Ensure adequate air flow when rack or plinth mounting the console.

CUE SHEET - Copy this sheet and use it to mark up your control settings.

1	2	3	4	5	6	7	8	9	10	11	12	13	14	15	16	17	18	19	20	21	22	23	24	25	26	27	28	29	30	31	32	33	34	35	36	37	38	39	40	41	42	43	44	45	46	47	48	49	50	51	52	53	54	55	56	57	58	59	60	61	62	63	64	65	66	67	68	69	70	71	72	73	74	75	76	77	78	79	80	81	82	83	84	85	86	87	88	89	90	91	92	93	94	95	96	97	98	99	100
---	---	---	---	---	---	---	---	---	----	----	----	----	----	----	----	----	----	----	----	----	----	----	----	----	----	----	----	----	----	----	----	----	----	----	----	----	----	----	----	----	----	----	----	----	----	----	----	----	----	----	----	----	----	----	----	----	----	----	----	----	----	----	----	----	----	----	----	----	----	----	----	----	----	----	----	----	----	----	----	----	----	----	----	----	----	----	----	----	----	----	----	----	----	----	----	----	----	----	-----

ALLEN&HEATH

REVERB
 HALL
 CH. RM 1
 ROOM1
 ROOM2
 ROOM3
 PLATE 1
 PLATE 2
 BATHS
 SEL

EFFECTS
 DEAN 1
 CH. RM 1
 CH. RM 2
 CHORUS
 LARGER
 PHASER

INTERNAL FX
 FB1
 FB2
 FX

EXTERNAL FX
 FB1
 FB2
 FX

PA -CP CONSTANT POWER
 STANDBY
 MONO OUT
 STEREO
 2TRK OUT
 2TRK L
 2TRK R
 POST OUT

EQ A
 LF: 30, 100, 300, 1000, 3000, 10000, 30000 Hz
 HF: 10, 30, 100, 300, 1000, 3000, 10000, 30000 Hz

EQ B
 LF: 30, 100, 300, 1000, 3000, 10000, 30000 Hz
 HF: 10, 30, 100, 300, 1000, 3000, 10000, 30000 Hz

AMP A
 SOLO
 STEREO
 MONO
 2TRK
 2TRK L
 2TRK R

AMP B
 SOLO
 STEREO
 MONO
 2TRK
 2TRK L
 2TRK R

Check out our Internet site :

<http://www.allen-heath.com/>